

CASEGOODS

PRICEBOOK



FRIANT AT A GLANCE

COMPONENTS

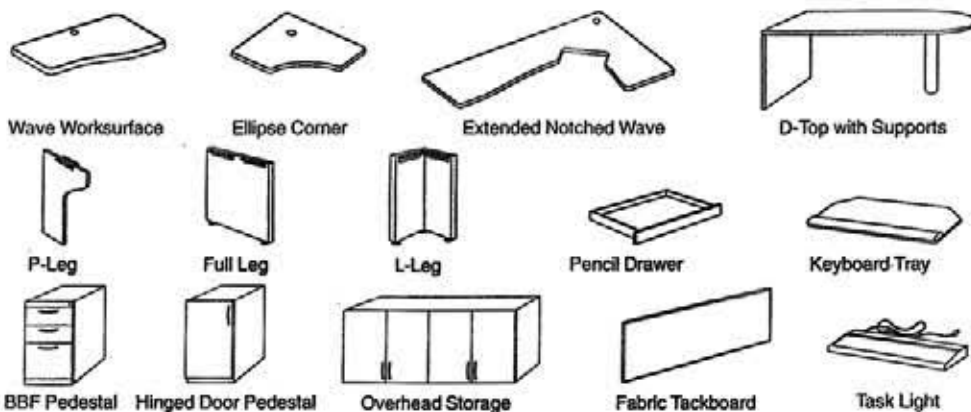
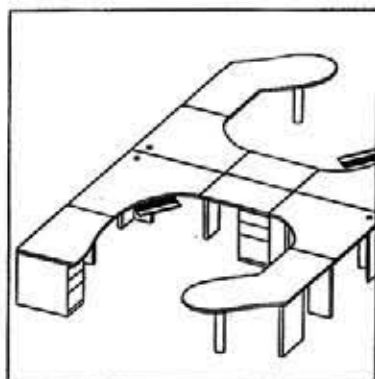

CASEGOODS

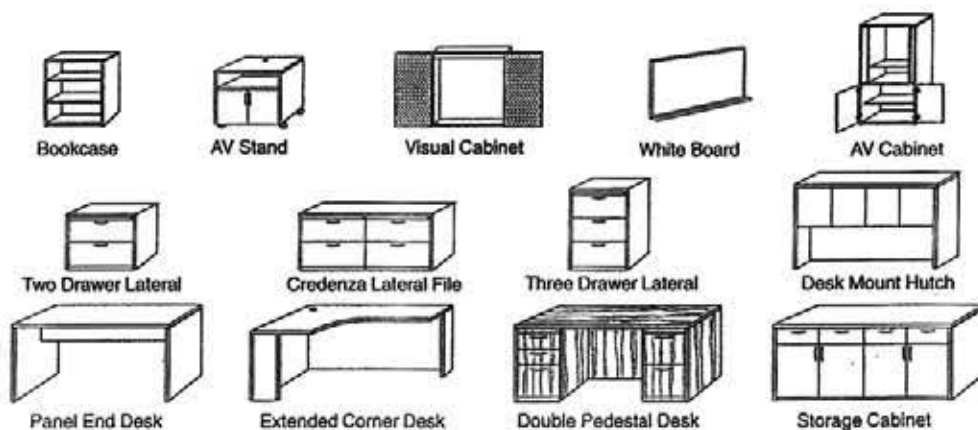
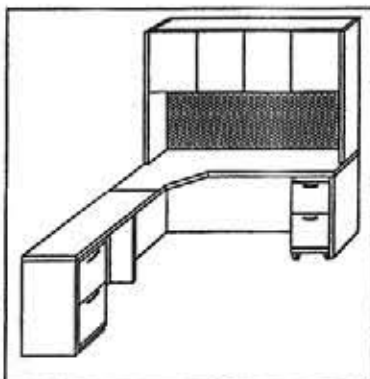

TABLES

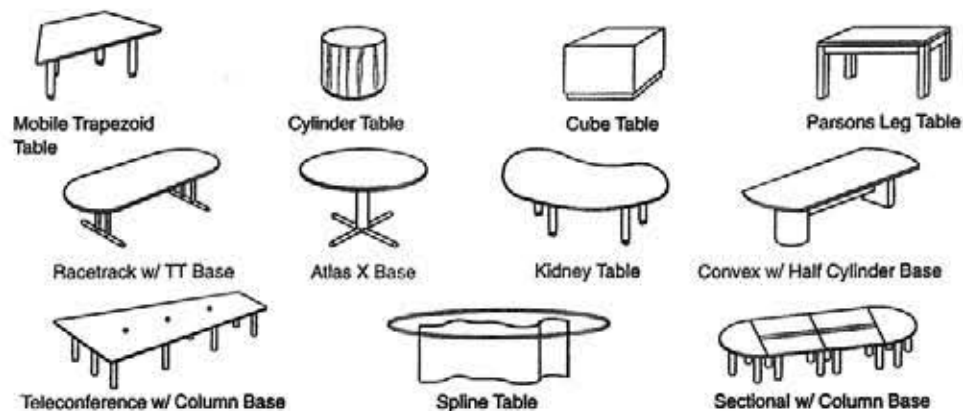
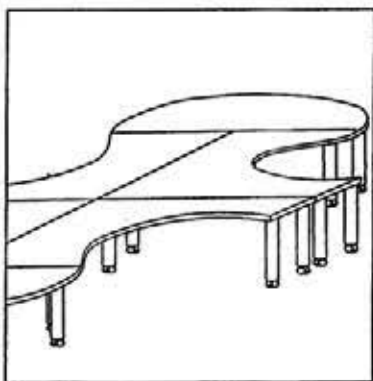

RECEPTION STATONS

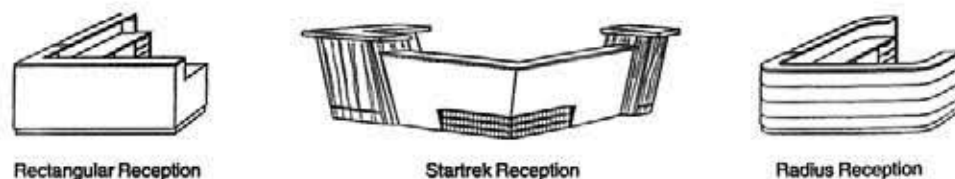
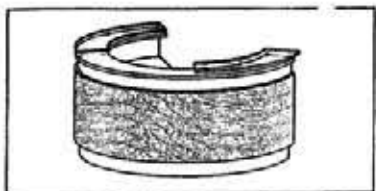

TABLE OF CONTENTS

GENERAL INFORMATION	5
Overview of Friant & Price List	
Terms & Conditions	
Edge Details	
Corner Details	
Product Specifications & Finishes	
COMPONENTS	15
Worksurfaces & Transaction Tops	
Grommet Locations	
Support & Modesty Panels	
Optional Accessories	
Pedestals & Files	
Overhead Storage	
Tackboards	
CASEGOODS	41
Desks	
Returns, Bridges & Corners	
Peninsula Desks	
Desk Mount Hutches	
Bookcases	
Lateral Files & Credenzas	
Storage Units	
Video Cabinets	
Visual & White Boards	
TABLES	59
General/Conference Tables	
Occasional Tables	
RECEPTION STATIONS	69
Rectangular	
Radius Corner	

GENERAL INFORMATION

3

Terms and Conditions

PRICES

All Prices are F.O.B. point. We reserve the right to change prices without prior notice.

ORDERING

Purchase Orders should be sent to Friant & Associates, LLC at orders@friant.com, or faxed to (510) 535-6895. If your specifications were created with CAP, GIZA or Project Matrix, please send the worksheet (SP4) with your Purchase Order.

TERMS

Net 30 days from date of invoice. Invoices are delinquent if not paid 30 days from date of invoice. In the event timely payment is not made, interest will be charged at the rate of 1.5% per month on delinquent accounts. Buyers will also be liable for normal collection costs and attorney's fee. 50% deposit is required with every order, unless prior arrangements have been made.

ORDERS

Orders are only accepted by issuance of our formal acknowledgment, and are subject to the terms set forth herein and on our order acknowledgment. It is the responsibility of the buyer to review our acknowledgment for accuracy.

SHIPPING

Friant generally palletizes, boxes and/or shrink-wraps its products. If buyer requests additional packaging or special shipping, then it is responsible for any extra costs that result. Buyer obtains title to products and assumes the risk of loss for them upon shipment from Friant's plant.

CLAIMS

We are not responsible for damage suffered in transit. Merchandise should be inspected for possible freight damage upon delivery. The consignee should file for damage or shortages with the carrier within 5 days of delivery. You are also protected for "concealed damage" if you file claim with the carrier within 5 days of delivery. Buyer must make all claims against Friant for defects, errors or shortages in writing within 10 days after delivery. Failure to make such a claim shall constitute full acceptance.

RETURNS

No merchandise may be returned without our written consent and shipping instructions. Unauthorized returns will not be accepted and will be returned freight collect.

PARTIAL SHIPMENTS

We will make every attempt to ship orders complete and on schedule. However, we reserve the right to make partial shipments, as merchandise is ready. Invoices covering these shipments are to be paid as they become due.

ORDER CHANGE — CANCELLATIONS

Our order confirmation is final and binding. Any order change or cancellation is subject to our ability to conform. For the most up to date information, always review the order change/cancellation policy online. Allowable changes within the posted policy must be made in writing.

SHIPMENT AND PREPAID FREIGHT

Unless otherwise instructed, we reserve the option to ship by what is, in our opinion, the best possible way. Upon request, we will prepay and add freight for accounts with established credit.

DELIVERY

We are not liable for delay or failure of delivery due to strikes and/or differences with workmen, war, riot, fire, compliance with government regulations, acts of nature, failure or delays of sources of supply, or any other causes beyond our control.

STORAGE

If buyer cannot accept delivery when merchandise is ready, we reserve the right to transfer goods to storage. Costs of transfer and storage will be charged to the buyer's account, and we will deem such transfer as constituting shipment for all purposes, including invoicing, as of the date the transfer is made.

CONSTRUCTION — SPECIFICATIONS

All items are produced to price list specifications unless otherwise advised. All dimensions shown are approximate. Manufacturer reserves the right to make modifications and/or improvements without prior notice.

FABRIC APPLICATION

Standard fabric application is Non-Directional application. Certain product construction and sizes require fabric to be applied only Directionally or Non-Directionally. See individual pricebook specifications for details.

Friant & Associates is not responsible for charges associated with replacement of products due to incorrect specifications.

CUSTOMER'S OWN MATERIAL Yardage requirement is based on 66" wide plain covering material, and must be increased if less than 66" wide. Special instructions for handling material (pattern, directional fabric, right side of reversible fabric, etc.) must be submitted in writing before fabric is delivered. In the absence of special instructions, we reserve the right to use our own judgment. We reserve the right to reject any covering, which in our opinion, is unsuitable for our upholstery purposes. However, in no instance shall we be held responsible for unsatisfactory results due to use of covering unsuitable for our upholstery methods.

We will not be responsible for errors caused by buyers not supplying us with sample cuttings attached to their order giving full identification of covering material, (name of supplier, covering name, number and color) for identification purposes and advising us of model number and quantity to which each cover is to be applied.

Customer's own material that is shipped freight collect will be refused. A service charge will be applied for the return of unusable C.O.M. Contact factory.

Terms and Conditions continued..

RIGHTS AND WARRANTIES — LIMITED LIFETIME WARRANTY

This warranty is given to the initial purchaser and is valid from the date of purchase, for as long as the initial purchaser owns the product. This warranty covers defects in material and craftsmanship found during normal usage of the product during the warranty period. Normal usage is defined by 8 hour shifts in the product's intended application and in an indoor environment that conforms to the ANSI/ASHRAE Standard 55: Thermal Environmental Conditions for Human Occupancy (relating to air temperature, mean radiant temperature, air velocity, clothing insulation, metabolic rate, and humidity). Friant's warranty does not cover usage other than normal usage as defined in the previous sentence. If the product is defective, and if written notice of the defect is given to Friant & Associates within the applicable warranty period, Friant & Associates, at its option, will either repair or replace the defective product with a comparable component or product. This warranty applies to all products except as noted below.

High wear parts, such as wood veneer, fabrics, and other covering material/finishes, foam, glides, etc. are warranted for one (1) year. This warranty does not apply to damage caused by a carrier, alteration to the product not expressly authorized by Friant & Associates, nor to product considered to be of a consumable nature such as bulbs, light ballasts, etc. It also does not apply to "Customer's Own Material" (i.e. material specified by the customer that is not a standard Friant & Associates offering) used in the manufacture of Friant & Associates products.

Our warranty for LED lights is 2 years.

Friant & Associates does not warrant the matching of colors, grain or texture, except to within commercially acceptable standards.

This includes normal variations between dye lots (fabrics).

A product will not be considered defective, and Friant & Associates will not be obligated to replace it, if it is not installed in a proper manner (i.e. product not leveled, not secured properly, etc.) or if it is not used in a manner and/or in an environment that constitutes normal usage, as defined above.

Except as noted above, Friant & Associates makes no express or implied warranties to any product, and in particular makes no warranty of fitness for any particular use. At Friant & Associates' option, product repair and replacement is the customer's exclusive remedy for any and all product defects.

Friant & Associates shall not be liable for consequential, economic, or incidental damages arising from any product defect.

CALIFORNIA PROP 65 WARNING

Products in this catalog can expose you to chemicals including wood dust, which is known to the State of California to cause cancer or birth defects or other reproductive harm. For more information go to <https://www.p65warnings.ca.gov/products/furniture-products>."

CARB

Friant products are CARB 93120 compliant for formaldehyde (phase 2)

TSCA Title VI

Friant products are TSCA Title VI Compliant

MAS

Accredited Compliance Designation - ANSI/BIFMA x7.1 & e3-2014 7.6.1, 7.6.2, 7.6.3
California Dept. Of Public Health Standard Method v1.2
Conforms With: LEED v4
Criteria of MAS Certified Green ® Program

EDGE DETAILS

The following edge details are available on all products in this catalog. Prices in each section are based on Group Number, actual edge within each Group must be specified.

GROUP 1 - LAMINATE TOP

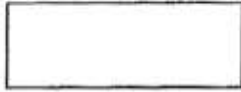

Laminate Self Edge
1 1/4" Thick

GROUP 2 - LAMINATE TOP

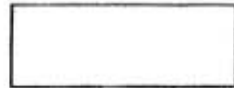

3mm PVC Edge
1 1/4" Thick

GROUP 3 - LAMINATE TOP

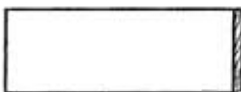

1/4" Wood Eased Edge
1 1/4" Thick

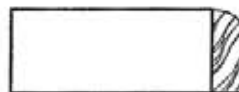

1/2" Wood Radius Edge
1 1/4" Thick

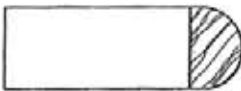

3/4" Wood Bullnose Edge
1 1/4" Thick

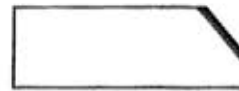

3/4" Black Reveal Bevel Edge
1 1/4" Thick

GROUP 4 - VENEER TOP



Veneer
1/4" Wood Eased Edge
1 1/4" Thick



Veneer
1/2" Wood Radius Edge
1 1/4" Thick

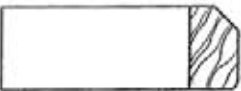

Veneer
3/4" Wood Bevel Edge
1 1/4" Thick



Veneer
3/4" Wood Bullnose Edge *
1 1/4" Thick

**Note: not available on all products.*

EDGE DETAILS - CONFERENCE TABLES

The following edge details are available on conference tables only. Prices in each section are based on Group Number, actual edge within each Group must be specified.

GROUP 1 - LAMINATE TOP

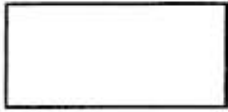

Laminate Self Edge
1 1/4" Thick

GROUP 2 - LAMINATE TOP

GROUP 3 - LAMINATE TOP

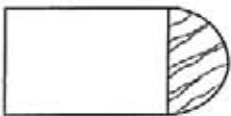

Bullnose Wood Edge
1" Wide x 1 1/4" Thick

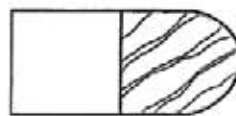

Bullnose Wood Edge
1 1/4" Wide x 1 1/4" Thick
5% upcharge

GROUP 5 - VENEER TOP

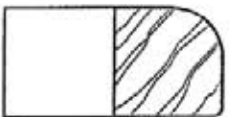

Veneer
Radius Wood Edge
1 1/4" Wide x 1 1/4" Thick

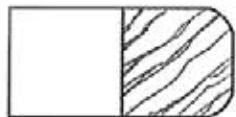

Veneer
Double Radius Wood Edge
1 1/4" Wide x 1 1/4" Thick

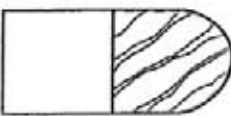

Veneer
Bullnose Wood Edge
1 1/4" Wide x 1 1/4" Thick

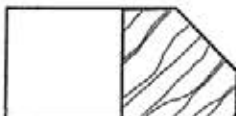

Veneer
Bevel Wood Edge
1 1/4" Wide x 1 1/4" Thick

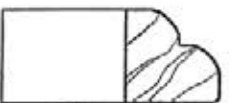

Veneer
Double Radius Wood Edge
1 1/4" Wide x 1 1/4" Thick

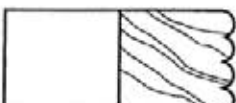

Veneer
Beaded Wood Edge
1 1/4" Wide x 1 1/4" Thick



Veneer
Knife Wood Edge
1 1/4" Wide x 1 1/4" Thick



Veneer
Reverse Knife Wood Edge
1 1/4" Wide x 1 1/4" Thick

CORNER DETAILS - CASEGOODS

The following drawings show the corner details for each Group Number and Edge design. Top design and end panel design are identified in each drawing. On all of the series, except as noted, the end panel continues to the floor with no extra base detail. Adjustable glides complete the unit.

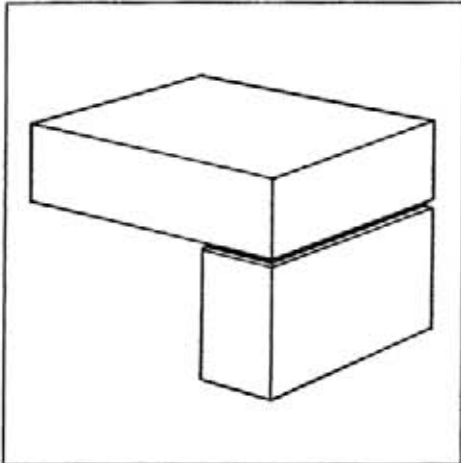

Group 1 - Laminate Self Edge Top & End Panel, 1¼" Thick

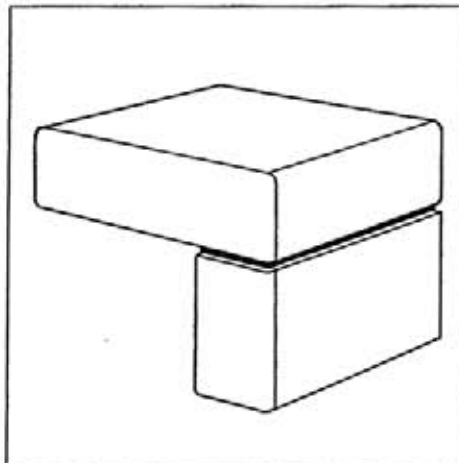

Group 2 - Laminate Top with 3mm PVC Edge & Self Edge End Panel, 1¼" Thick

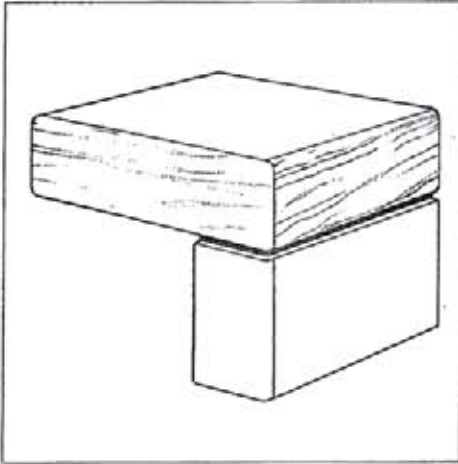

Group 3 - Laminate Top & End Panel with 1/4" Wood Eased Edge, 1 1/4" Thick

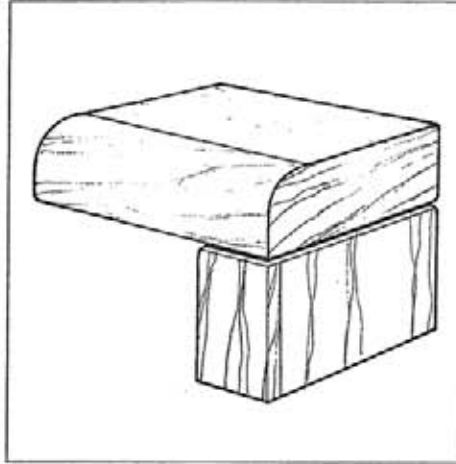

Group 3 - Laminate Top with 1/2" Wood Radius Edge & Laminate End Panel with 1/4" Wood Eased Edge, 1 1/4" Thick

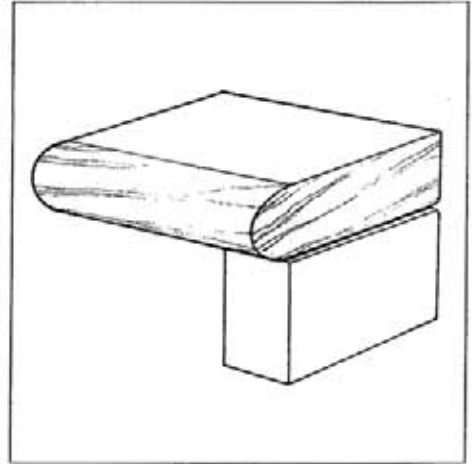

Group 3 - Laminate Top with 3/4" Wood Bullnose Edge & Self Edge End Panel, 1 1/4" Thick

Group 4 - Veneer Top & End Panel with 1/4" Wood Eased Edge, 1 1/4" Thick

Group 4 - Veneer Top with 1/2" Wood Radius Edge & Veneer End Panel with 1/4" Wood Eased Edge, 1 1/4" Thick

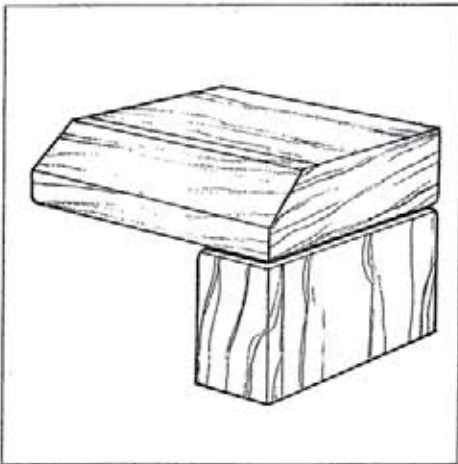

Group 4 - Veneer Top with 1/2" Wood Bevel Edge & Veneer End Panel with 1/4" Wood Eased Edge, 1 1/4" Thick

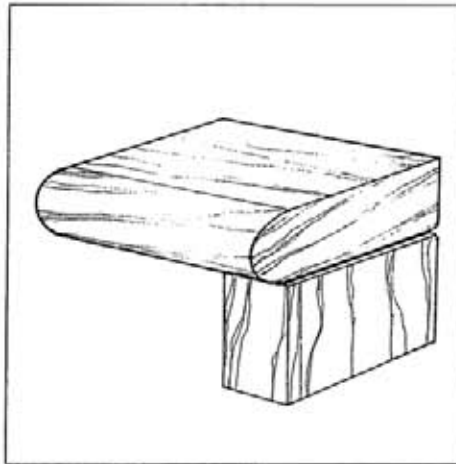

Group 4 - Veneer Top with 3/4" Wood Bullnose Edge & Veneer End Panel with 1/4" Wood Eased Edge, 1 1/4" Thick

PRODUCT SPECIFICATIONS

COMPONENTS OVERVIEW

The components section offers worksurfaces and supports available in a wide range of sizes and shapes. Components can be designed to meet specifications of various major O.E.M. sources (see below) for use in both new and used configurations. These worksurfaces are also suitable for generic systems use or can be adapted to fit with the systems products of other manufacturers. Also, because pedestals and modesty panels are available, full freestanding units can be built from the components found here.

When specifying components please use the following O.E.M. Manufacturer Codes: H.W. - Haworth; H.M. - Herman Miller; A.S. - AllSteel; S.C. - Steelcase; H.N. - Hon and T.N. - Teknion. (Company names are registered trademarks and are not associated with Friant.) These parts are authorized only by Friant and originate with Friant. Specifications are subject to change without notice.

Worksurfaces and supports can be made compatible with any other furniture system. Simply state manufacturer to be matched.

For orders of 50 or more worksurfaces, call the factory for pricing. Custom sizes and shapes are available. Contact the factory for assistance.

SPECIFICATIONS

LAMINATE SPECIFICATIONS & FINISHES

Friant uses 45lb density 1-1/8" industrial grade particle board. Our horizontal worksurfaces are finished with high pressure laminate on top and high pressure backing sheet on bottom. Particle board build-up is applied to increase thickness of tops when necessary.

Friant offers solid and woodgrain laminates with a "textured" finish by Wilsonart, Nevamar, Formica, and Pionite. Most colors and patterns are standard. Please consult factory to verify availability.

"Gloss" laminates have a high sheen, glass-like finish that is very susceptible to scratching. Gloss finishes require more expensive material and additional labor costs. Please consult factory for further information.

Laminates by other manufacturers are available and may be subject to additional costs. Call the factory for more information.

Note: Because Friant does not manufacture the high pressure laminates used in our products, we are subject to product modifications and price increases by the laminate manufacturer.

VENEER SPECIFICATIONS & FINISHES

Friant's standard veneers and solid hardwoods are White Oak, Walnut, Cherry and Maple. Other veneers, such as Rift Oak, Ribbon Mahogany, Birdseye, or special woodgrains are also available. Call the factory for pricing.

Please call the factory for information on special wood stains and finishes.

PRODUCT SPECIFICATIONS

SPECIFICATIONS, continued

DRAWER SPECIFICATIONS

Drawer bodies consist of ½" particle board core with black vinyl surface and mitre fold construction. As an option, maple hardwood with dowel construction and a clear lacquer finish is available.

Veneer and laminate wood grain drawer faces are vertically matched, individually and across desks and credenzas.

Box Drawers:

- 3½" inside height x 15⅞", 21", or 25⅞" deep (depending on overall depth of pedestal).
- Equipped with Accuride suspensions.
- Adjustable drawer divider included.
- Pencil tray included in top box drawer.

File Drawers:

- 9" inside height x 15⅞", 21", or 25⅞" deep (depending on overall depth of pedestal).
- Pedestals are letter size with 12¼" inside width.
- Side-to-side pendaflex filing is standard, front-to-back filing is available. Call factory for pricing.

Lateral Files:

- All lateral file drawers have 15⅞" inside depth, no matter the overall depth of file.
- Pendaflex filing

KEYBOARD MECHANISMS

Standard Adjustable Keyboard Arm:

Weber Knapp Micro Arm #14915

ClickIt Adjustable Keyboard Arm:

ClickIt is the latest "intuitive" keyboard arm, one hand...one motion raises it to working height. No knobs or levers to release, nothing in the kneespace to tear your clothes or bang your knees. ClickIt offers over 10° of vertical adjustment, putting you into compliance with the newest ANSI/HFS-100 specifications. ClickIt's tray adjusts for positive/negative tilt, to help keep the wrists straight, and can be shifted left/right of center to keep the user centered on the arm for unparalleled stability. ClickIt is spring-assisted: it feels light as a feather in your hand and never drops into your lap.

- Height: 10.3"
- Tilt: ±15° (will become ±10°)
- Lateral: 4" (will become 5")
- Fully retracts on track as short as 18"

KEY LOCKS/ CORES

Casegoods locking storage uses the LAM3 series locks. LAM3 locks are available. They are sold separately through the Willow catalog. Please see Willow Pricebook for part numbers and pricing.

CUSTOMS

All custom work is welcomed. Please call the factory.



COMPONENTS

STRAIGHT WORKSURFACES

EDGE DETAILS

MODEL NUMBER	SIZE D x W	WT.	EDGE DETAILS			
			GROUP 1	GROUP 2	GROUP 3	GROUP 4
STRAIGHT						
WS 2024	20 x 24	17	100	140	190	275
WS 2030	20 x 30	21	105	145	216	308
WS 2036	20 x 36	25	110	150	250	347
WS 2048	20 x 48	33	120	160	270	445
WS 2060	20 x 60	42	135	175	343	525
WS 2072	20 x 72	50	160	200	375	550
WS 2096	20 x 96	67	210	285	606	700
WS 20120	20 x 120	83	265	365	750	850
WS 20144	20 x 144	100	375	475	875	1000
WS 2424	24 x 24	20	100	140	200	275
WS 2430	24 x 30	25	105	145	235	290
WS 2436	24 x 36	30	110	150	260	325
WS 2448	24 x 48	40	120	160	300	445
WS 2460	24 x 60	50	135	175	352	525
WS 2472	24 x 72	60	160	200	410	550
WS 2496	24 x 96	80	250	285	620	700
WS 24120	24 x 120	100	275	390	775	850
WS 24144	24 x 144	120	395	475	847	1000
WS 3024	30 x 24	25	105	170	240	315
WS 3030	30 x 30	31	115	170	265	375
WS 3036	30 x 36	38	120	175	296	410
WS 3048	30 x 48	50	140	185	345	468
WS 3060	30 x 60	63	175	225	385	565
WS 3072	30 x 72	75	200	250	525	665
WS 3096	30 x 96	100	275	350	730	880
WS 30120	30 x 120	125	325	435	860	1000
WS 30144	30 x 144	150	425	510	1060	1200

WHEN ORDERING SPECIFY

- MODEL NUMBER & DESCRIPTION, INCLUDING OPTIONS
- SIZE
- EDGE DETAIL
- GROMMET LOCATION
- FINISH
- OEM MANUFACTURER, IF APPLICABLE

NOTES & OPTIONS

- PRICE & ORDER SUPPORTS SEPARATELY
- INTERMEDIATE SIZES - PRICE AT NEXT LARGEST SIZE, SPECIFY AND CHANGE MODEL NUMBER
- FOR 36" DEEP WORKSURFACES ADD 20% TO 30" DEEP PRICES
- FRIANT MANUFACTURES TOPS SIZED TO FIT ANY OEM SYSTEM, PLEASE SPECIFY WHICH SYSTEM (SEE PAGE 12)

STRAIGHT WORKSURFACES

EDGE DETAILS

MODEL NUMBER	SIZE D x W	WT.	EDGE DETAILS			
			GROUP 1	GROUP 2	GROUP 3	GROUP 4

SHAPED STRAIGHT WORKSURFACES

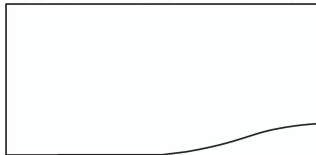

Wave

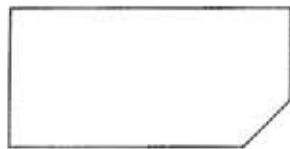

Clipped Corner

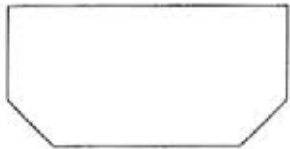

Double Clipped Corner

SWS 2424	24 x 24	17	110	150	210	320
SWS 2430	24 x 30	21	115	160	250	360
SWS 2436	24 x 36	25	120	165	288	400
SWS 2448	24 x 48	33	132	175	330	440
SWS 2460	24 x 60	42	145	190	405	550
SWS 2472	24 x 72	50	175	220	439	600
SWS 2496	24 x 96	67	275	313	700	800
SWS 24120	24 x 120	83	300	420	920	986
SWS 24144	24 x 144	100	410	522	1000	1160
SWS 3024	30 x 24	20	115	160	250	335
SWS 3030	30 x 30	25	125	175	285	375
SWS 3036	30 x 36	30	130	180	325	410
SWS 3048	30 x 48	40	150	190	350	510
SWS 3060	30 x 60	50	190	230	431	675
SWS 3072	30 x 72	60	220	235	570	900
SWS 3096	30 x 96	80	300	360	750	1050
SWS 30120	30 x 120	100	350	425	1025	1160
SWS 30144	30 x 144	120	450	535	1100	1350

Specify design of worksurface.

WHEN ORDERING SPECIFY

- MODEL NUMBER & DESCRIPTION, INCLUDING OPTIONS
- SIZE
- EDGE DETAIL
- GROMMET LOCATION
- FINISH
- OEM MANUFACTURER, IF APPLICABLE

NOTES & OPTIONS

- PRICE & ORDER SUPPORTS SEPARATELY
- INTERMEDIATE SIZES - PRICE AT NEXT LARGEST SIZE, SPECIFY AND CHANGE MODEL NUMBER
- FOR 36" DEEP WORKSURFACES ADD 20% TO 30" DEEP PRICES
- FRIANT MANUFACTURES TOPS SIZED TO FIT ANY OEM SYSTEM, PLEASE SPECIFY WHICH SYSTEM (SEE PAGE 12)

CORNER WORKSURFACES

MODEL NUMBER	SIZE D x W	WT.	EDGE DETAILS			
			GROUP 1	GROUP 2	GROUP 3	GROUP 4

ANGLED CORNER

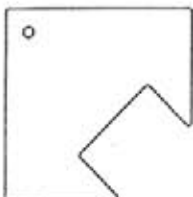

ACWS 3636	36 x 36	41	160	200	350	385
ACWS 4242	42 x 42	53	220	250	375	412
ACWS 4848	48 x 48	70	250	260	388	426
ACWS 6060	60 x 60	109	345	385	561	617

Dimensions of sides that connect with other worksurfaces need to be specified. Standard sizes are 20", 24", and 30". Please specify both the left side dimension and the right side dimension.

Optional keyboard cutout shown, not included in price - add \$60 list.

CURVED CORNER



CCWS 3636	36 x 36	41	175	205	420	517
CCWS 4242	42 x 42	53	230	265	470	575
CCWS 4848	48 x 48	70	250	265	470	575
CCWS 6060	60 x 60	109	345	385	595	720

Dimensions of sides that connect with other worksurfaces need to be specified. Standard sizes are 20", 24", and 30". Please specify both the left side dimension and the right side dimension.

WHEN ORDERING SPECIFY

- MODEL NUMBER & DESCRIPTION, INCLUDING OPTIONS
- SIZE
- EDGE DETAIL
- GROMMET LOCATION
- FINISH
- OEM MANUFACTURER, IF APPLICABLE

NOTES & OPTIONS

- PRICE & ORDER SUPPORTS SEPARATELY
- INTERMEDIATE SIZES - PRICE AT NEXT LARGEST SIZE, SPECIFY AND CHANGE MODEL NUMBER
- OPTIONAL KEYBOARD CUTOUT AVAILABLE ON ALL CORNER WORKSURFACES - ADD \$60 LIST & SPECIFY
- FRIANT MANUFACTURES TOPS SIZED TO FIT ANY OEM SYSTEM, PLEASE SPECIFY WHICH SYSTEM (SEE PAGE 12)

CORNER WORKSURFACES

MODEL NUMBER	SIZE D x W	WT.	EDGE DETAILS			
			GROUP 1	GROUP 2	GROUP 3	GROUP 4

ELIPSE CORNER

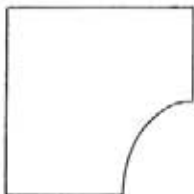

ECWS 3636	36 x 36	41	175	205	420	517
ECWS 4242	42 x 42	53	230	265	470	575
ECWS 4848	48 x 48	70	250	265	470	575
ECWS 6060	60 x 60	109	345	385	595	720

Dimensions of sides that connect with other worksurfaces need to be specified. Standard sizes are 20", 24", and 30". Please specify both the left side dimension and the right side dimension.

NOTCHED CORNER

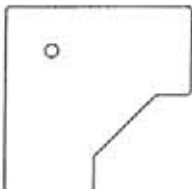

NCWS 3636	36 x 36	41	175	205	420	517
NCWS 4242	42 x 42	53	230	265	470	575
NCWS 4848	48 x 48	70	250	265	470	575
NCWS 6060	60 x 60	109	345	385	595	720

Dimensions of sides that connect with other worksurfaces need to be specified. Standard sizes are 20", 24", and 30". Please specify both the left side dimension and the right side dimension.

WHEN ORDERING SPECIFY

- MODEL NUMBER & DESCRIPTION, INCLUDING OPTIONS
- SIZE
- EDGE DETAIL
- GROMMET LOCATION
- FINISH
- OEM MANUFACTURER, IF APPLICABLE

NOTES & OPTIONS

- PRICE & ORDER SUPPORTS SEPARATELY
- INTERMEDIATE SIZES - PRICE AT NEXT LARGEST SIZE, SPECIFY AND CHANGE MODEL NUMBER
- OPTIONAL KEYBOARD CUTOUT AVAILABLE ON ALL CORNER WORKSURFACES - ADD \$60 LIST & SPECIFY
- FRIANT MANUFACTURES TOPS SIZED TO FIT ANY OEM SYSTEM, PLEASE SPECIFY WHICH SYSTEM (SEE PAGE 12)

EXTENDED CORNER WORKSURFACES

MODEL NUMBER	SIZE D x W	WT.	EDGE DETAILS			
			GROUP 1	GROUP 2	GROUP 3	GROUP 4

EXTENDED ANGLED CORNER



Right Extension Shown

EACWS 3660	36 x 60	57	235	275	480	590
EACWS 3672	36 x 72	66	275	300	550	695
EACWS 3696	36 x 96	82	390	450	600	800
EACWS 4248	42 x 48	57	250	265	440	600
EACWS 4260	42 x 60	65	285	345	550	685
EACWS 4272	42 x 72	74	315	357	600	775
EACWS 4296	42 x 96	90	530	630	800	980
EACWS 4860	48 x 60	80	285	350	550	785
EACWS 4872	48 x 72	90	395	475	620	900
EACWS 4896	48 x 96	110	530	640	900	1040

Dimensions of sides that connect with other worksurfaces need to be specified. Standard sizes are 20°, 24°, and 30°. Please specify both the left side dimension and the right side dimension.

Specify right extension or left extension. Add -R or -L to model number.

WHEN ORDERING SPECIFY

- MODEL NUMBER & DESCRIPTION, INCLUDING OPTIONS
- SIZE
- EDGE DETAIL
- GROMMET LOCATION
- FINISH
- OEM MANUFACTURER, IF APPLICABLE

NOTES & OPTIONS

- PRICE & ORDER SUPPORTS SEPARATELY
- INTERMEDIATE SIZES - PRICE AT NEXT LARGEST SIZE, SPECIFY AND CHANGE MODEL NUMBER
- OPTIONAL KEYBOARD CUTOUT AVAILABLE ON ALL CORNER WORKSURFACES - ADD \$60 LIST & SPECIFY
- FRIANT MANUFACTURES TOPS SIZED TO FIT ANY OEM SYSTEM, PLEASE SPECIFY WHICH SYSTEM (SEE PAGE 12)

EXTENDED CORNER WORKSURFACES

EDGE DETAILS

MODEL NUMBER	SIZE D x W	WT.	EDGE DETAILS			
			GROUP 1	GROUP 2	GROUP 3	GROUP 4

EXTENDED NOTCHED CORNER

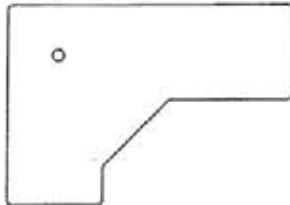

Right Extension Shown

ENCWS 4248	42 x 48	53	250	300	520	637
ENCWS 4260	42 x 60	61	320	390	535	685
ENCWS 4272	42 x 72	70	335	418	600	775
ENCWS 4296	42 x 96	86	530	645	750	980
ENCWS 4860	48 x 60	76	320	400	550	685
ENCWS 4872	48 x 72	86	385	462	630	800
ENCWS 4896	48 x 96	106	530	635	900	1040
ENCWS 6072	60 x 72	106	550	635	900	1110
ENCWS 6096	60 x 96	126	650	785	1100	1250

Dimensions of sides that connect with other worksurfaces need to be specified. Standard sizes are 20", 24", and 30". Please specify both the left side dimension and the right side dimension.

Specify right extension or left extension. Add -R or -L to model number.

WHEN ORDERING SPECIFY

- MODEL NUMBER & DESCRIPTION, INCLUDING OPTIONS
- SIZE
- EDGE DETAIL
- GROMMET LOCATION
- FINISH
- OEM MANUFACTURER, IF APPLICABLE

NOTES & OPTIONS

- PRICE & ORDER SUPPORTS SEPARATELY
- INTERMEDIATE SIZES - PRICE AT NEXT LARGEST SIZE, SPECIFY AND CHANGE MODEL NUMBER
- OPTIONAL KEYBOARD CUTOUT AVAILABLE ON ALL CORNER WORKSURFACES - ADD \$60 LIST & SPECIFY
- FRIANT MANUFACTURES TOPS SIZED TO FIT ANY OEM SYSTEM, PLEASE SPECIFY WHICH SYSTEM (SEE PAGE 12)

EXTENDED CORNER WORKSURFACES

MODEL NUMBER	SIZE D x W	WT.	EDGE DETAILS			
			GROUP 1	GROUP 2	GROUP 3	GROUP 4

EXTENDED CURVED CORNER

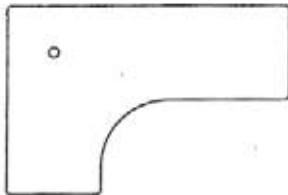

Right Extension Shown

ECCWS 4260	42 x 60	61	320	390	630	822
ECCWS 4272	42 x 72	70	335	418	700	930
ECCWS 4296	42 x 96	86	530	645	860	1176
ECCWS 4860	48 x 60	70	320	410	630	822
ECCWS 4872	48 x 72	78	385	465	700	930
ECCWS 4896	48 x 96	95	530	635	860	1176
ECCWS 6072	60 x 72	100	550	650	900	1332
ECCWS 6096	60 x 96	115	650	785	1100	1500

Dimensions of sides that connect with other worksurfaces need to be specified. Standard sizes are 20", 24", and 30". Please specify both the left side dimension and the right side dimension.

Specify right extension or left extension. Add -R or -L to model number.

WHEN ORDERING SPECIFY

- MODEL NUMBER & DESCRIPTION, INCLUDING OPTIONS
- SIZE
- EDGE DETAIL
- GROMMET LOCATION
- FINISH
- OEM MANUFACTURER, IF APPLICABLE

NOTES & OPTIONS

- PRICE & ORDER SUPPORTS SEPARATELY
- INTERMEDIATE SIZES - PRICE AT NEXT LARGEST SIZE, SPECIFY AND CHANGE MODEL NUMBER
- OPTIONAL KEYBOARD CUTOUT AVAILABLE ON ALL CORNER WORKSURFACES - ADD \$60 LIST & SPECIFY
- FRIANT MANUFACTURES TOPS SIZED TO FIT ANY OEM SYSTEM, PLEASE SPECIFY WHICH SYSTEM (SEE PAGE 12)

EXTENDED CORNER WORKSURFACES

EDGE DETAILS

MODEL NUMBER	SIZE D x W	WT.	EDGE DETAILS			
			GROUP 1	GROUP 2	GROUP 3	GROUP 4

EXTENDED ELIPSE CORNER

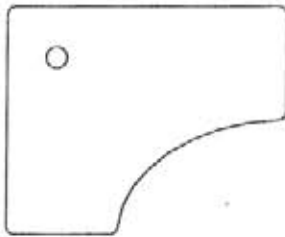

Right Extension Shown

EECWS 4260	42 x 60	61	320	390	630	822
EECWS 4272	42 x 72	70	335	418	700	930
EECWS 4296	42 x 96	86	530	645	860	1176
EECWS 4860	48 x 60	70	320	410	630	822
EECWS 4872	48 x 72	78	385	465	700	930
EECWS 4896	48 x 96	95	530	645	860	1176
EECWS 6072	60 x 72	100	550	650	900	1332
EECWS 6096	60 x 96	115	650	785	1100	1500

Dimensions of sides that connect with other worksurfaces need to be specified. Standard sizes are 20", 24", and 30". Please specify both the left side dimension and the right side dimension.

Specify right extension or left extension. Add -R or -L to model number.

WHEN ORDERING SPECIFY

- MODEL NUMBER & DESCRIPTION, INCLUDING OPTIONS
- SIZE
- EDGE DETAIL
- GROMMET LOCATION
- FINISH
- OEM MANUFACTURER, IF APPLICABLE

NOTES & OPTIONS

- PRICE & ORDER SUPPORTS SEPARATELY
- INTERMEDIATE SIZES - PRICE AT NEXT LARGEST SIZE, SPECIFY AND CHANGE MODEL NUMBER
- OPTIONAL KEYBOARD CUTOUT AVAILABLE ON ALL CORNER WORKSURFACES - ADD \$60 LIST & SPECIFY
- FRIANT MANUFACTURES TOPS SIZED TO FIT ANY OEM SYSTEM, PLEASE SPECIFY WHICH SYSTEM (SEE PAGE 12)

PENINSULA WORKSURFACES

EDGE DETAILS

MODEL NUMBER	SIZE D x W	WT.	EDGE DETAILS			
			GROUP 1	GROUP 2	GROUP 3	GROUP 4
D SHAPE						
DT 2436	24 x 36	30	147	190	500	800
DT 2448	24 x 48	40	158	200	540	845
DT 2460	24 x 60	50	180	215	573	895
DT 2472	24 x 72	60	210	246	617	930
DT 2496	24 x 96	80	280	310	650	960
DT 3036	30 x 36	38	170	200	565	869
DT 3048	30 x 48	50	180	220	575	890
DT 3060	30 x 60	63	210	252	617	929
DT 3072	30 x 72	75	225	275	663	1000
DT 3096	30 x 96	100	330	365	721	1040
DT 3660	36 x 60	75	230	275	682	960
DT 3672	36 x 72	90	300	336	715	990
DT 3696	36 x 96	120	400	430	819	1133

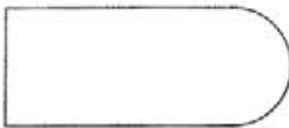

WHEN ORDERING SPECIFY

- MODEL NUMBER & DESCRIPTION, INCLUDING OPTIONS
- SIZE
- EDGE DETAIL
- GROMMET LOCATION
- FINISH
- OEM MANUFACTURER, IF APPLICABLE

NOTES & OPTIONS

- PRICE & ORDER SUPPORTS SEPARATELY
- INTERMEDIATE SIZES - PRICE AT NEXT LARGEST SIZE, SPECIFY AND CHANGE MODEL NUMBER
- FRIANT MANUFACTURES TOPS SIZED TO FIT ANY OEM SYSTEM, PLEASE SPECIFY WHICH SYSTEM (SEE PAGE 12)

PENINSULA WORKSURFACES

EDGE DETAILS

MODEL NUMBER	SIZE D/Radius x W	WT.	EDGE DETAILS			
			GROUP 1	GROUP 2	GROUP 3	GROUP 4

P SHAPE

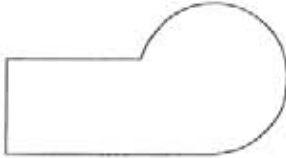

Right Extension Shown

PT 24/3666	24/36 x 66	70	330	396	1025	1280
PT 24/3672	24/36 x 72	75	330	396	1025	1280
PT 24/3696	24/36 x 96	95	410	490	1220	1475
PT 30/4266	30/42 x 66	86	385	465	1010	1350
PT 30/4272	30/42 x 72	92	385	465	1010	1350
PT 30/4296	30/42 x 96	117	550	600	1400	1600
PT 36/4872	36/48 x 72	110	385	465	1010	1380
PT 36/4896	36/48 x 96	140	588	705	1010	1630
PT 36/5496	36/54 x 96	154	700	840	1870	2100
PT 36/6096	36/60 x 96	170	700	840	1870	2100

Specify right extension or left extension. Add -R or -L to model number.

WHEN ORDERING SPECIFY

- MODEL NUMBER & DESCRIPTION, INCLUDING OPTIONS
- SIZE
- EDGE DETAIL
- GROMMET LOCATION
- FINISH
- OEM MANUFACTURER, IF APPLICABLE

NOTES & OPTIONS

- PRICE & ORDER SUPPORTS SEPARATELY
- INTERMEDIATE SIZES - PRICE AT NEXT LARGEST SIZE, SPECIFY AND CHANGE MODEL NUMBER
- FRIANT MANUFACTURES TOPS SIZED TO FIT ANY OEM SYSTEM, PLEASE SPECIFY WHICH SYSTEM (SEE PAGE 12)

PENINSULA WORKSURFACES

MODEL NUMBER	SIZE D/D2 x W	WT.	EDGE DETAILS			
			GROUP 1	GROUP 2	GROUP 3	GROUP 4

THUMB SHAPE

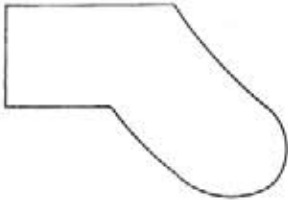

Right Extension Shown

TM 24/3666	24/36 x 66	70	400	440	1200	1350
TM 24/3672	24/36 x 72	75	450	475	1200	1400
TM 24/3696	24/36 x 96	95	500	550	1375	1550
TM 30/4266	30/42 x 66	86	410	450	1220	1380
TM 30/4272	30/42 x 72	92	470	515	1220	1380
TM 30/4296	30/42 x 96	117	525	575	1400	1600

Specify right extension or left extension. Add -R or -L to model number.

Dimensions measured as shown below:

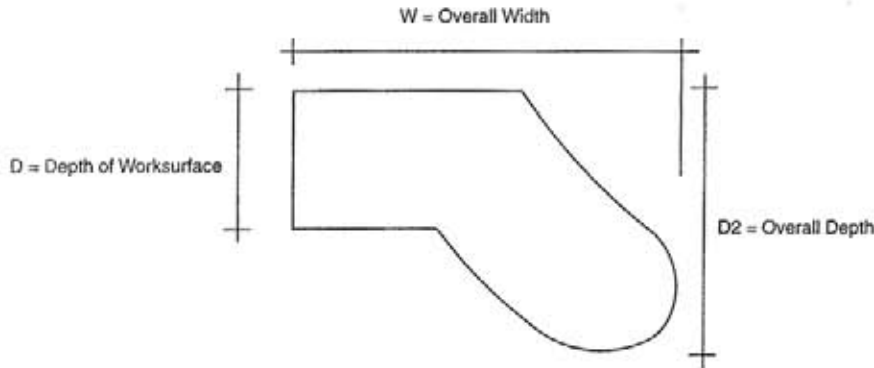

WHEN ORDERING SPECIFY

- MODEL NUMBER & DESCRIPTION, INCLUDING OPTIONS
- SIZE
- EDGE DETAIL
- GROMMET LOCATION
- FINISH
- OEM MANUFACTURER, IF APPLICABLE

NOTES & OPTIONS

- PRICE & ORDER SUPPORTS SEPARATELY
- INTERMEDIATE SIZES - PRICE AT NEXT LARGEST SIZE, SPECIFY AND CHANGE MODEL NUMBER
- FRIANT MANUFACTURES TOPS SIZED TO FIT ANY OEM SYSTEM, PLEASE SPECIFY WHICH SYSTEM (SEE PAGE 12)

PENINSULA WORKSURFACES

MODEL NUMBER	SIZE D/Radius x W	WT.	EDGE DETAILS			
			GROUP 1	GROUP 2	GROUP 3	GROUP 4
J SHAPE						
JT 24/3666	24/36 x 66	70	330	396	1080	1280
JT 24/3672	24/36 x 72	75	330	396	1080	1280
JT 24/3696	24/36 x 96	95	410	490	1250	1475
JT 30/4266	30/42 x 66	86	385	465	1111	1350
JT 30/4272	30/42 x 72	92	385	465	1111	1350
JT 30/4296	30/42 x 96	117	550	600	1385	1600
JT 36/4872	36/48 x 72	110	385	465	1111	1380
JT 36/4896	36/48 x 96	140	588	705	1385	1630
JT 36/5496	36/54 x 96	154	700	840	1890	2000
JT 36/6096	36/60 x 96	170	700	840	1890	2000



Right Extension Shown

Specify right extension or left extension. Add -R or -L to model number.

WHEN ORDERING SPECIFY

- MODEL NUMBER & DESCRIPTION, INCLUDING OPTIONS
- SIZE
- EDGE DETAIL
- GROMMET LOCATION
- FINISH
- OEM MANUFACTURER, IF APPLICABLE

NOTES & OPTIONS

- PRICE & ORDER SUPPORTS SEPARATELY
- INTERMEDIATE SIZES - PRICE AT NEXT LARGEST SIZE, SPECIFY AND CHANGE MODEL NUMBER
- FRIANT MANUFACTURES TOPS SIZED TO FIT ANY OEM SYSTEM, PLEASE SPECIFY WHICH SYSTEM (SEE PAGE 12)

EXTENDED PENINSULA WORKSURFACES

EDGE DETAILS

MODEL NUMBER	SIZE D x W	WT.	EDGE DETAILS			
			GROUP 1	GROUP 2	GROUP 3	GROUP 4

EXTENDED CURVED CORNER D SHAPE

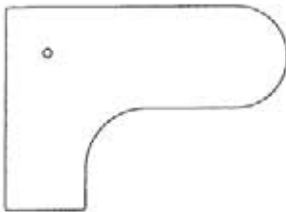

Right Extension Shown

EDCCWS 4860	48 x 60	65	420	460	900	1250
EDCCWS 4872	48 x 72	84	446	500	1100	1325
EDCCWS 4896	48 x 96	117	525	575	1350	1700
EDCCWS 6072	60 x 72	110	525	575	1450	1700
EDCCWS 6096	60 x 96	135	665	720	1620	2000

Dimension of side that connects with another work surface needs to be specified. Depth of bullet top also needs to be specified. Standard sizes are 20", 24", and 30".

36" and 42" depths available, specify and call factory for pricing.

Specify right extension or left extension. Add -R or -L to model number.

WHEN ORDERING SPECIFY

- MODEL NUMBER & DESCRIPTION, INCLUDING OPTIONS
- SIZE
- EDGE DETAIL
- GROMMET LOCATION
- FINISH
- OEM MANUFACTURER, IF APPLICABLE

NOTES & OPTIONS

- PRICE & ORDER SUPPORTS SEPARATELY
- INTERMEDIATE SIZES - PRICE AT NEXT LARGEST SIZE, SPECIFY AND CHANGE MODEL NUMBER
- FRIANT MANUFACTURES TOPS SIZED TO FIT ANY OEM SYSTEM, PLEASE SPECIFY WHICH SYSTEM (SEE PAGE 12)

CURVED WORKSURFACES

MODEL NUMBER	SIZE	WT.	EDGE DETAILS			
			GROUP 1	GROUP 2	GROUP 3	GROUP 4

QUARTER CIRCLE

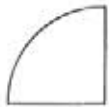

WSQC 24	24 x 24	20	130	165	300	400
WSQC 30	30 x 30	33	135	165	300	400
WSQC 36	36 x 36	47	160	190	400	450

HALF CIRCLE



HCWS 2448	24 x 48	43	160	235	490	570
HCWS 2460	24 x 60	53	200	250	500	600
HCWS 3060	30 x 60	64	210	250	520	610
HCWS 3072	30 x 72	77	225	285	550	665

WHEN ORDERING SPECIFY

- MODEL NUMBER & DESCRIPTION, INCLUDING OPTIONS
- SIZE
- EDGE DETAIL
- GROMMET LOCATION
- FINISH
- OEM MANUFACTURER, IF APPLICABLE

NOTES & OPTIONS

- PRICE & ORDER SUPPORTS SEPARATELY
- INTERMEDIATE SIZES - PRICE AT NEXT LARGEST SIZE, SPECIFY AND CHANGE MODEL NUMBER
- FRIANT MANUFACTURES TOPS SIZED TO FIT ANY OEM SYSTEM, PLEASE SPECIFY WHICH SYSTEM (SEE PAGE 12)

TRANSACTION TOPS

EDGE DETAILS

MODEL NUMBER	SIZE D x W	WT.	EDGE DETAILS			
			GROUP 1	GROUP 2	GROUP 3	GROUP 4
STRAIGHT TRANSACTION TOP						
CTS 1524	15 x 24	13	85	125	300	425
CTS 1530	15 x 30	17	90	130	310	450
CTS 1536	15 x 36	19	95	135	350	475
CTS 1548	15 x 48	26	105	145	400	500
CTS 1560	15 x 60	32	120	160	425	575
CTS 1572	15 x 72	38	140	180	475	625
CTS 1596	15 x 96	51	200	265	600	675



Optional Radius End Top

12" deep counter tops available. Specify and change model number. No upcharge
For radius end top add 30%.

L TRANSACTION TOP

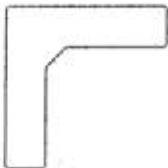

CS 30	12 x 30 x 30	21	160	205	500	600
CS 36	12 x 36 x 36	25	160	205	500	600
CS 42	12 x 42 x 42	31	220	260	575	700
CS 48	12 x 48 x 48	35	220	260	575	700
CS 60	12 x 60 x 60	45	340	357	700	865

WHEN ORDERING SPECIFY

- MODEL NUMBER & DESCRIPTION, INCLUDING OPTIONS
- SIZE
- EDGE DETAIL
- FINISH
- OEM MANUFACTURER, IF APPLICABLE

NOTES & OPTIONS

- PRICE & ORDER SUPPORTS SEPARATELY
- INTERMEDIATE SIZES - PRICE AT NEXT LARGEST SIZE, SPECIFY AND CHANGE MODEL NUMBER
- FRIANT MANUFACTURES TOPS SIZED TO FIT ANY OEM SYSTEM, PLEASE SPECIFY WHICH SYSTEM (SEE PAGE 12)

GROMMET LOCATIONS

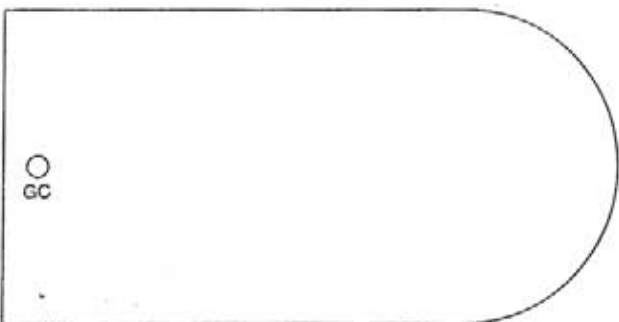
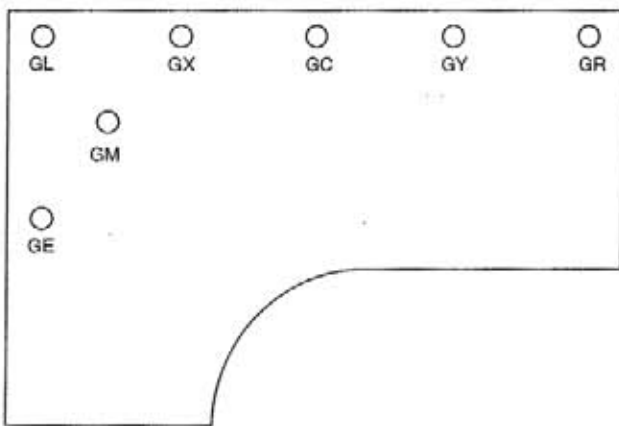
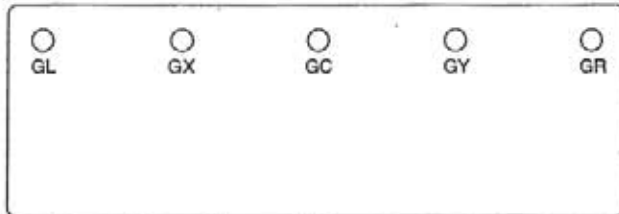

LEGEND

Refer to the illustrations at left for all standard grommet locations.

A 3" round grommet with cover is standard.
GC is standard location unless otherwise specified.

Specify positioning as follows:

Common Combinations

- G1 Pair of grommets at locations GL and GR
- G2 Pair of grommets at locations GL and GC
- G3 Pair of grommets at locations GC and GR
- G4 Pair of grommets at locations GX and GY
- G5 Three grommets at locations GL, GC and GR

Code Position

Code	Position
GL	4" from left side - 4" from rear
GR	4" from right side - 4" from rear
GC	Centered side to side - 4" from rear
GX	Centered between GL and GC positions - 4" from rear
GY	Centered between GC and GR positions - 4" from rear
GM	12" from each side
GE	Centered front to back - 4" from side

Dimensions are measured from grommet center to top edge.

Note: For other grommet locations call factory for pricing.

Standard grommet finishes are: black, dark grey, light grey, and beige.

WORKSURFACE SUPPORT PANELS

MODEL NUMBER	SIZE D x H	WT.	OPTIONS		
			BLACK	LAMINATE	VENEER

FULL LEG

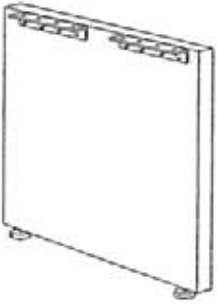

WSP 2029	20 x 27 $\frac{3}{4}$	19	90	145	265
WSP 2429	24 x 27 $\frac{3}{4}$	23	100	165	265
WSP 3029	30 x 27 $\frac{3}{4}$	29	115	175	275
WSP 3629	36 x 27 $\frac{3}{4}$	33	130	195	300

These supports are used to create a freestanding unit. Use support panels at ends of worksurfaces or where they connect. When support panels are used where two worksurfaces connect, a mending plate is required.

P LEG



PSP 2029	20 x 27 $\frac{3}{4}$	19	90	145	300
PSP 2429	24 x 27 $\frac{3}{4}$	23	100	165	300
PSP 3029	30 x 27 $\frac{3}{4}$	29	115	175	315
PSP 3629	36 x 27 $\frac{3}{4}$	33	130	195	345

These supports are used to create a freestanding unit. Use support panels at ends of worksurfaces or where they connect. When support panels are used where two worksurfaces connect, a mending plate is required.

WHEN ORDERING SPECIFY

- MODEL NUMBER & DESCRIPTION, INCLUDING OPTIONS
- SIZE
- EDGE DETAIL
- FINISH
- OEM MANUFACTURER, IF APPLICABLE

NOTES & OPTIONS

- FRIANT MANUFACTURES SUPPORTS SIZED TO FIT ANY OEM SYSTEM, PLEASE SPECIFY WHICH SYSTEM (SEE PAGE 12)

WORKSURFACE SUPPORT PANELS

MODEL NUMBER	SIZE D x H	WT.	OPTIONS		
			BLACK	LAMINATE	VENEER

C LEG

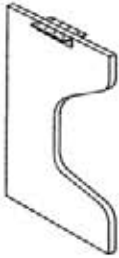

CSP 2029	20 x 27 $\frac{3}{4}$	19	90	145	300
CSP 2429	24 x 27 $\frac{3}{4}$	23	100	165	300
CSP 3029	30 x 27 $\frac{3}{4}$	29	115	175	315
CSP 3629	36 x 27 $\frac{3}{4}$	33	130	195	345

These supports are used to create a freestanding unit. Use support panels at ends of worksurfaces or where they connect. When support panels are used where two worksurfaces connect, a mending plate is required.

HALF LEG



HSP 1229	12 x 27 $\frac{3}{4}$	12	75	95	195
HSP 1529	15 x 27 $\frac{3}{4}$	15	85	120	225

These supports are used to create a freestanding unit. Use support panels at ends of worksurfaces or where they connect. When support panels are used where two worksurfaces connect, a mending plate is required.

WHEN ORDERING SPECIFY

- MODEL NUMBER & DESCRIPTION, INCLUDING OPTIONS
- SIZE
- EDGE DETAIL
- FINISH
- OEM MANUFACTURER, IF APPLICABLE

NOTES & OPTIONS

- FRIANT MANUFACTURES SUPPORTS SIZED TO FIT ANY OEM SYSTEM, PLEASE SPECIFY WHICH SYSTEM (SEE PAGE 12)

WORKSURFACE SUPPORTS AND MODESTY PANELS

MODEL NUMBER	SIZE D x H	WT.	OPTIONS		
			BLACK	LAMINATE	VENEER

CORNER LEG - L SHAPE

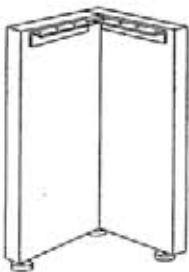

LSP 1229	12 x 27 $\frac{3}{4}$	12	145	195	300
LSP 1529	15 x 27 $\frac{3}{4}$	15	155	200	325
LSP 2029	20 x 27 $\frac{3}{4}$	19	165	250	355

These supports are used to create a freestanding unit.
Use at back corner of a corner worksurface.

MODESTY PANEL



FMSP-3629	36 x 27 $\frac{3}{4}$	35	145	165	275
FMSP-4829	48 x 27 $\frac{3}{4}$	47	175	205	425
FMSP-6029	60 x 27 $\frac{3}{4}$	59	220	255	480
FMSP-7229	72 x 27 $\frac{3}{4}$	70	275	315	600
FMSP-9629	96 x 27 $\frac{3}{4}$	94	350	400	850
FMSP-12029	120 x 27 $\frac{3}{4}$	117	420	483	1015

Half height or three-quarter height modesty panels available - call factory for pricing and specifications.

COLUMN BASE



			BLACK	CHROME	OTHER POWDERCOAT
ME-3	3" Dia x 27 $\frac{3}{4}$	6	120	130	*
ME-4	4" Dia x 27 $\frac{3}{4}$	9	160	170	*
ME-6	6" Dia x 27 $\frac{3}{4}$	13	275	285	*

* Call factory for pricing.

WHEN ORDERING SPECIFY

- MODEL NUMBER & DESCRIPTION, INCLUDING OPTIONS
- SIZE
- EDGE DETAIL
- FINISH
- OEM MANUFACTURER, IF APPLICABLE

NOTES & OPTIONS

- CABLE CUT-OUT - SPECIFY LOCATION AND ADD \$25 LIST
- FRIANT MANUFACTURES SUPPORTS SIZED TO FIT ANY OEM SYSTEM, PLEASE SPECIFY WHICH SYSTEM (SEE PAGE 12)

OPTIONAL ACCESSORIES

MODEL NUMBER	SIZE W x D x H	WT.	OPTIONS		
			BLACK	LAMINATE	VENEER
PD	22 x 16	20	135	150	210

PENCIL DRAWER



WIRE MANAGER



MODEL NUMBER	SIZE W x D x H	WT.	BLACK
WM-2-36	36 x 1 x 2		40
WM-2-48	48 x 1 x 2		55
WM-2-60	60 x 1 x 2		65
WM-2-72	72 x 1 x 2		80

Mounts at back of, or underneath, worksurface.

KEYBOARD PLATFORMS W/ ARTICULATING ARM



Shown w/ Wrist Rest

MODEL NUMBER	SIZE W x D x H	WT.	STANDARD MECHANISM	CLICK-IT MECHANISM
Rectangular Platform w/o Wrist Rest				
2111 - R	21 x 11	6	235	N/A
Rectangular Platform w/ Wrist Rest				
2111 - RW	21 x 11	6	285	410
Clipped Corner Platform w/o Wrist Rest				
2811 - C	28 x 11	6	235	410
Clipped Corner Platform w/ Wrist Rest				
2811 - CW	28 x 11	6	285	410



Shown w/ Wrist Rest

Add C-1 to model number for Click-It mechanism.

WHEN ORDERING SPECIFY

- MODEL NUMBER & DESCRIPTION, INCLUDING OPTIONS
- SIZE
- FINISH

NOTES & OPTIONS

- KEYBOARD PLATFORM IS BLACK MELAMINE
- WRIST REST IS 3" DEEP X 3/4" HIGH AND IS FABRIC COVERED
- STANDARD ARTICULATING ARM IS WEBER KNAPP MICRO ARM #14915
- CLICK-IT IS SPRING-ASSISTED AND REQUIRES NO KNOBS OR LEVERS - SEE PAGE 13 FOR SPECIFICATIONS

PEDESTALS

MODEL NUMBER	SIZE D x W x H	WT.	OPTIONS			
			BLACK UNFINISHED BACK	LAMINATE UNFINISHED BACK	LAMINATE FINISHED BACK	VENEER FINISHED BACK

BOX, BOX, FILE



BBF	22 x 16 x 27	96	275	325	375	800
-----	--------------	----	-----	-----	-----	-----

Standard with lock.

FILE, FILE



FF	22 x 16 x 27	96	275	325	375	800
----	--------------	----	-----	-----	-----	-----

Standard with lock.

HINGED DOOR



HD	22 x 16 x 27	95	275	390	450	700
----	--------------	----	-----	-----	-----	-----

Specify hinges at left or right. No lock.
For lock - add \$60 list and specify.

LATERAL FILE

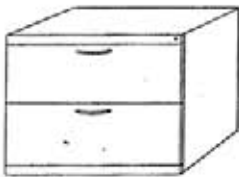

LF - 30	22 x 30 x 27	180	500	620	700	1000
LF - 36	22 x 36 x 27	210	500	620	700	1000

Standard with lock.

WHEN ORDERING SPECIFY

- MODEL NUMBER & DESCRIPTION, INCLUDING OPTIONS
- SIZE
- FINISH

NOTES & OPTIONS

- FOR MOBILE PEDESTAL SPECIFY AND ADD \$60 PER PEDESTAL
- STANDARD WITH FRIANT BLACK HANDLES
- STANDARD WITH UNFINISHED TOP
- FOR FREESTANDING UNITS ADD WORKSURFACE, SEE PAGE 16

- **KEY LOCKS/ CORES** - Casegoods locking storage uses the LAM3 series locks. LAM3 locks are available. They are sold separately through the Willow catalog.
- Please see Willow Pricebook for part numbers and pricing.

OVERHEAD STORAGE

MODEL NUMBER	SIZE D x W x H	WT.	OPTIONS		
			BLACK	LAMINATE	VENEER
OPEN SHELF					
WMOS 1536	15 x 36 x 18	66	400	500	645
WMOS 1548	15 x 48 x 18	78	475	570	675
WMOS 1560	15 x 60 x 18	90	525	620	775
WMOS 1572	15 x 72 x 18	102	625	700	950
WMOS 1596	15 x 96 x 18	125	745	870	1100

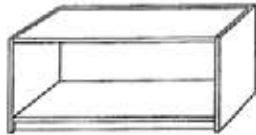

SINGLE HEIGHT FLIPPER OR HINGED DOOR CABINET

WMFD 1536	15 x 36 x 18	100	600	675	715
WMFD 1548	15 x 48 x 18	125	650	750	850
WMFD 1560	15 x 60 x 18	145	695	825	975
WMFD 1572	15 x 72 x 18	180	800	910	1050
WMFD 1596	15 x 96 x 18	220	900	1050	1350

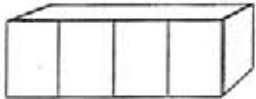
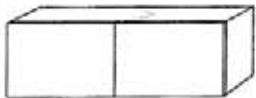

Standard flipper door flips over top. For hinged doors specify and change F to H in model number.

DOUBLE HIGH HINGED DOOR CABINET

WMHD 1536 - 30	15 x 36 x 30	185	685	760	1072
WMHD 1548 - 30	15 x 48 x 30	230	750	840	1125
WMHD 1560 - 30	15 x 60 x 30	265	865	965	1375
WMHD 1572 - 30	15 x 72 x 30	330	980	1075	1525

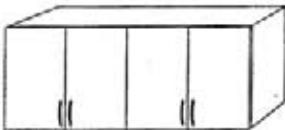

TASK LIGHT



			PUTTY
TL 24 (Fits 30-36" shelf)	24.20"	7	135
TL 36 (Fits 42-48" shelf)	36.20"	9	145
TL 48 (Fits 60" shelf)	48.20"	11	155
TL 60 (Fits 72" shelf)	60"	13	175

WHEN ORDERING SPECIFY

- MODEL NUMBER & DESCRIPTION, INCLUDING OPTIONS
- SIZE
- FINISH

NOTES & OPTIONS

- WALL MOUNT CLEATS INCLUDED, CALL FOR PANEL MOUNT CLEAT INFORMATION AND PRICING
- TASK LIGHT STANDARD WITH 9' CORD ON RIGHT

- **KEY LOCKS/ CORES** - Caseloads locking storage uses the LAM3 series locks. LAM3 locks are available. They are sold separately through the Willow catalog.
- Please see Willow Pricebook for part numbers and pricing.

FABRIC TACKBOARDS

MODEL NUMBER	SIZE H x W	WT.	OPTIONS
			FABRIC

SQUARE EDGE TACKBOARD



Square Edge

TB __36	18 x 36	9	165
TB __48	18 x 48	12	175
TB __60	18 x 60	15	185
TB __72	18 x 72	18	240
TB __96	18 x 96	24	280

Heights of 18" - 24" are same price. Please specify height and fill in model number, i.e., TB 1836.

TB __36	30 x 36	15	185
TB __48	30 x 48	20	210
TB __60	30 x 60	25	265
TB __72	30 x 72	30	300
TB __96	30 x 96	40	425

Heights of 30" - 36" are same price. Please specify and fill in model number, i.e. TB 3036.

TB 4836	48 x 36	18	200
TB 4848	48 x 48	24	265
TB 4860	48 x 60	30	300
TB 4872	48 x 72	36	357
TB 4896	48 x 96	48	465

WHEN ORDERING SPECIFY

- MODEL NUMBER & DESCRIPTION, INCLUDING OPTIONS
- SIZE
- FABRIC

NOTES & OPTIONS

- SPECIFY SQUARE EDGE OR RADIUS EDGE
- TACKBOARDS ARE 1" THICK, WITH WALL CLEAT AND TASKLIGHT CORD CUTOUT INCLUDED
- INTERMEDIATE SIZES - PRICE AT NEXT LARGEST SIZE, SPECIFY AND CHANGE MODEL NUMBER



CASEGOODS

TABLE DESKS

MODEL NUMBER	SIZE D x W	WT.	EDGE DETAILS			
			GROUP 1	GROUP 2	GROUP 3	GROUP 4
PANEL END TABLE						
PET 2024	20 x 24	57	360	410	600	725
PET 2030	20 x 30	64	400	460	650	775
PET 2036	20 x 36	71	420	485	685	800
PET 2048	20 x 48	85	460	529	742	825
PET 2060	20 x 60	100	500	575	810	900
PET 2072	20 x 72	114	545	626	850	945
PET 2430	24 x 30	85	400	460	650	775
PET 2436	24 x 36	93	420	483	685	800
PET 2448	24 x 48	109	460	529	742	825
PET 2460	24 x 60	125	500	575	810	900
PET 2472	24 x 72	141	545	626	850	945
PET 3036	30 x 36	111	450	520	685	800
PET 3048	30 x 48	129	520	600	756	840
PET 3060	30 x 60	147	555	638	780	865
PET 3072	30 x 72	165	660	750	883	950
PET 3660	36 x 60	194	675	770	930	1000
PET 3672	36 x 72	216	740	851	1064	1145
PET 3696	36 x 96	225	775	900	1150	1200

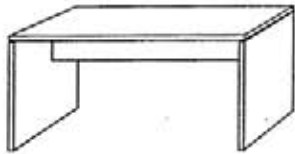

WHEN ORDERING SPECIFY

- MODEL NUMBER & DESCRIPTION, INCLUDING OPTIONS
- SIZE
- EDGE DETAIL
- FINISH

NOTES & OPTIONS

- STANDARD 10" HIGH MODESTY RECESSED 6" FROM BACK EDGE
- OPTIONAL CENTERED 10" MODESTY AVAILABLE
- INTERMEDIATE SIZES - PRICE AT NEXT LARGEST SIZE, SPECIFY AND CHANGE MODEL NUMBER

DESK & CREDENZA SHELLS

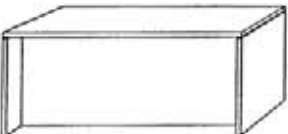
	MODEL NUMBER	SIZE D x W	WT.	EDGE DETAILS			
				GROUP 1	GROUP 2	GROUP 3	GROUP 4
DESK / CREDENZA SHELL							
 View As Seated	CS 2048	20 x 48	93	460	529	742	825
	CS 2060	20 x 60	113	500	575	810	900
	CS 2072	20 x 72	133	545	626	850	945
 Front View	DS 2448	24 x 48	131	460	529	742	825
	DS 2460	24 x 60	153	500	575	810	900
	DS 2472	24 x 72	175	545	626	850	945
	DS 3048	30 x 48	174	520	600	756	840
	DS 3060	30 x 60	198	555	638	780	865
	DS 3072	30 x 72	222	660	750	883	950
	DS 3660	36 x 60	218	675	770	930	1000
	DS 3672	36 x 72	244	740	851	1064	1145
	DS 3696	36 x 96	250	760	875	1125	1200

WHEN ORDERING SPECIFY

- MODEL NUMBER & DESCRIPTION, INCLUDING OPTIONS
- SIZE
- EDGE DETAIL
- FINISH

NOTES & OPTIONS

- INTERMEDIATE SIZES - PRICE AT NEXT LARGEST SIZE, SPECIFY AND CHANGE MODEL NUMBER
- ¾ MODESTY IS STANDARD, SPECIFY FULL MODESTY IF NEEDED

DESKS

MODEL NUMBER	SIZE D x W	WT.	EDGE DETAILS			
			GROUP 1	GROUP 2	GROUP 3	GROUP 4
SINGLE PEDESTAL DESK						
SP 2460	24 x 60	240	810	875	1110	1275
SP 2472	24 x 72	265	880	950	1150	1350
SP 3060	30 x 60	265	900	975	1200	1310
SP 3072	30 x 72	290	975	1050	1265	1385
SP 3672	36 x 72	325	1060	1150	1400	1575

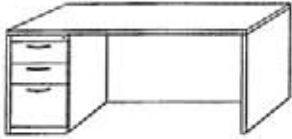

Specify left or right pedestal.

DOUBLE PEDESTAL DESK

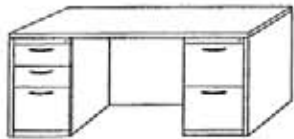

DP 2460	24 x 60	320	1150	1285	1660	1850
DP 2472	24 x 72	340	1230	1325	1760	1965
DP 3060	30 x 60	350	1225	1320	1690	1900
DP 3072	30 x 72	370	1300	1400	1750	1975
DP 3672	36 x 72	400	1395	1500	1900	2000

WHEN ORDERING SPECIFY

- MODEL NUMBER & DESCRIPTION, INCLUDING OPTIONS
- SIZE
- EDGE DETAIL
- FINISH

NOTES & OPTIONS

- INTERMEDIATE SIZES - PRICE AT NEXT LARGEST SIZE, SPECIFY AND CHANGE MODEL NUMBER
- STANDARD WITH LOCKS

- **KEY LOCKS/ CORES** - Casegoods locking storage uses the LAM3 series locks. LAM3 locks are available. They are sold separately through the Willow catalog.
- Please see Willow Pricebook for part numbers and pricing.

RETURNS

MODEL NUMBER	SIZE D x W	WT.	EDGE DETAILS			
			GROUP 1	GROUP 2	GROUP 3	GROUP 4

RETURN SHELL

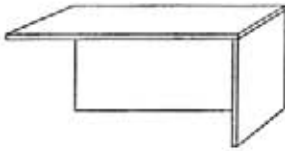

RS 2436	24 x 36	91	395	425	600	695
RS 2448	24 x 48	113	410	460	650	750
RS 2460	24 x 60	135	460	495	700	795
RS 2472	24 x 72	157	525	565	785	850
RS 3036	30 x 36	103	415	450	660	720
RS 3048	30 x 48	127	450	485	700	775
RS 3060	30 x 60	151	500	540	760	840
RS 3072	30 x 72	175	550	600	800	895

20" deep return available - specify & change model number.
Specify left or right return.

RETURN W/ PEDESTAL

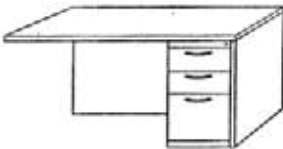

R 2436	24 x 36	177	730	795	995	1100
R 2448	24 x 48	199	780	840	1045	1165
R 2460	24 x 60	221	800	860	1100	1240

Specify left or right return.

WHEN ORDERING SPECIFY

- MODEL NUMBER & DESCRIPTION, INCLUDING OPTIONS
- SIZE
- EDGE DETAIL
- FINISH

NOTES & OPTIONS

- INTERMEDIATE SIZES - PRICE AT NEXT LARGEST SIZE, SPECIFY AND CHANGE MODEL NUMBER

- STANDARD WITH LOCKS

- **KEY LOCKS/ CORES** - Casegoods locking storage uses the LAM3 series locks. LAM3 locks are available. They are sold separately through the Willow catalog.
- Please see Willow Pricebook for part numbers and pricing.

BRIDGE & EXTENDED CORNER DESK

MODEL NUMBER	SIZE D x W	WT.	EDGE DETAILS			
			GROUP 1	GROUP 2	GROUP 3	GROUP 4
OPEN BRIDGE						
BR 2036	20 x 36	30	290	360	500	650
BR 2048	20 x 48	40	360	410	645	740
BR 2060	20 x 60	50	390	460	675	800
BR 2436	24 x 36	40	325	395	550	675
BR 2448	24 x 48	50	380	440	680	750
BR 2460	24 x 60	60	420	485	750	835
BR 3036	30 x 36	45	360	435	600	725
BR 3048	30 x 48	55	420	490	725	800
BR 3060	30 x 60	65	455	520	750	850

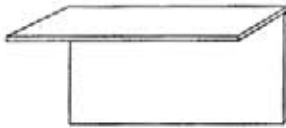

For optional modesty support panel see page 34.

EXTENDED CORNER DESK

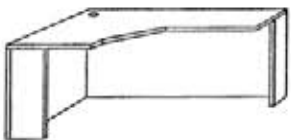
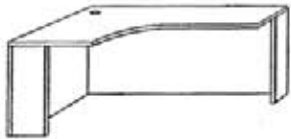

ECD 3660	36 x 60	220	895	990	1615	1900
ECD 3672	36 x 72	245	925	1025	1660	1950
ECD 3684	36 x 84	255	975	1085	1700	2000
ECD 3696	36 x 96	275	1055	1175	1765	2075
ECD 4860	48 x 60	280	975	1085	1660	1950
ECD 4872	48 x 72	285	1035	1148	1700	2000
ECD 4884	48 x 84	295	1075	1195	1765	2050
ECD 4896	48 x 96	300	1125	1250	1800	2100

Specify curved corner or straight corner.
Add \$80 for Keyboard Cutout.

WHEN ORDERING SPECIFY

- MODEL NUMBER & DESCRIPTION, INCLUDING OPTIONS
- SIZE
- EDGE DETAIL
- FINISH

NOTES & OPTIONS

- INTERMEDIATE SIZES - PRICE AT NEXT LARGEST SIZE, SPECIFY AND CHANGE MODEL NUMBER
- EXTENDED CORNER DESKS INCLUDE GROMMET

CORNER SHELL

EDGE DETAILS

MODEL NUMBER	SIZE D x W	WT.	EDGE DETAILS			
			GROUP 1	GROUP 2	GROUP 3	GROUP 4

ANGLED CORNER SHELL

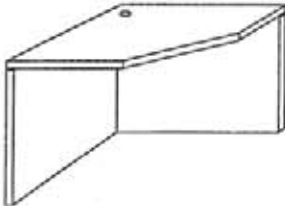

ACS 3636	36 x 36	116	575	610	980	1150
ACS 4242	42 x 42	141	625	700	1015	1225
ACS 4848	48 x 48	167	660	720	1040	1250

Dimensions of sides that connect with other units need to be specified. Standard sizes are 20", 24", and 30". Please specify both the left side dimension and the right side dimension.

Add \$80 List for Keyboard Cutout

CURVED CORNER SHELL

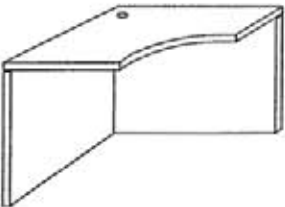

CCS 3636	36 x 36	119	595	630	1120	1275
CCS 4242	42 x 42	145	645	725	1175	1350
CCS 4848	48 x 48	172	680	750	1195	1375

Dimensions of sides that connect with other units need to be specified. Standard sizes are 20", 24", and 30". Please specify both the left side dimension and the right side dimension.

P-LEG CORNER SHELL

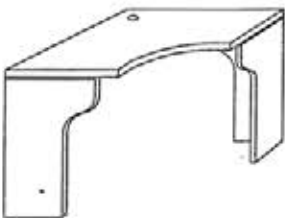

PCS 3636	36 x 36	100	535	570	875	1000
PCS 4242	42 x 42	130	580	635	900	1100
PCS 4848	48 x 48	145	630	685	1000	1200

Dimensions of sides that connect with other units need to be specified. Standard sizes are 20", 24", and 30". Please specify both the left side dimension and the right side dimension.

WHEN ORDERING SPECIFY

- MODEL NUMBER & DESCRIPTION, INCLUDING OPTIONS
- SIZE
- EDGE DETAIL
- FINISH

NOTES & OPTIONS

- INTERMEDIATE SIZES - PRICE AT NEXT LARGEST SIZE, SPECIFY AND CHANGE MODEL NUMBER
- INCLUDES CORNER GROMMET

PENINSULA DESKS

MODEL NUMBER	SIZE D x W	WT.	EDGE DETAILS			
			GROUP 1	GROUP 2	GROUP 3	GROUP 4
D-SHAPE - OPEN W/ COLUMN						
DD 2448	24 x 48	68	675	730	1150	1400
DD 2460	24 x 60	78	695	755	1250	1450
DD 2472	24 x 72	88	725	785	1285	1500
DD 3060	30 x 60	95	740	795	1285	1500
DD 3072	30 x 72	107	795	855	1340	1565
DD 3672	36 x 72	118	850	920	1395	1620
DD 3696	36 x 96	125	900	950	1425	1700

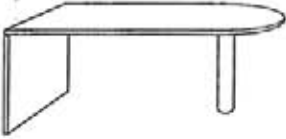

D-SHAPE - W/ FULL MODESTY PANEL W/ COLUMN

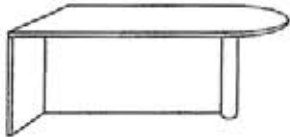

DDM 2448	24 x 48	118	850	905	1325	1825
DDM 2460	24 x 60	138	915	975	1470	1900
DDM 2472	24 x 72	161	1000	1060	1560	2050
DDM 3060	30 x 60	156	915	975	1485	2050
DDM 3072	30 x 72	180	1070	1295	1615	2110
DDM 3672	36 x 72	191	1125	1195	1670	2170
DDM 3696	36 x 96	205	1250	1345	1850	2295

WHEN ORDERING SPECIFY

- MODEL NUMBER & DESCRIPTION, INCLUDING OPTIONS
- SIZE
- EDGE DETAIL
- FINISH

NOTES & OPTIONS

- INTERMEDIATE SIZES - PRICE AT NEXT LARGEST SIZE, SPECIFY AND CHANGE MODEL NUMBER

DESK MOUNT HUTCH & BOOKCASES

MODEL NUMBER	SIZE D x W x H	WT.	OPTIONS	
			LAMINATE	GROUP 4 VENEER

FLIPPER OR HINGED DOOR DESK MOUNT HUTCH

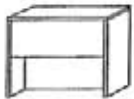

OSC 1536 - 42	15 x 36 x 42	141	925	1300
OSC 1548 - 42	15 x 48 x 42	175	985	1350
OSC 1560 - 42	15 x 60 x 42	212	1000	1380
OSC 1572 - 42	15 x 72 x 42	245	1100	1475

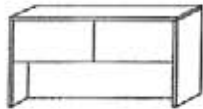

Specify flipper door or hinged door.
For optional top edge detail in groups 2 and 3 add \$70 list per linear foot.
Group 4 top edge detail is included.

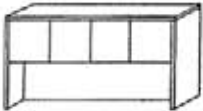

TWO SHELF BOOKCASE

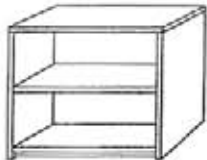

			BLACK	LAMINATE	VENEER
BC 1230-29	12 x 30 x 29	62	350	440	810
BC 1236-29	12 x 36 x 29	70	375	475	845
BC 1242-29	12 x 42 x 29	78	500	600	900
BC 1248-29	12 x 48 x 29	86	600	725	950

WHEN ORDERING SPECIFY

- MODEL NUMBER & DESCRIPTION, INCLUDING OPTIONS
- SIZE
- EDGE DETAIL
- FINISH

NOTES & OPTIONS

- HUTCH STANDARD WITH UNFINISHED BACK
- FOR LOCKS ADD \$50 AND SPECIFY

- **KEY LOCKS/ CORES** - Caseloads locking storage uses the LAM3 series locks. LAM3 locks are available. They are sold separately through the Willow catalog.
- Please see Willow Pricebook for part numbers and pricing.

BOOKCASES

MODEL NUMBER	SIZE D x W x H	WT.	OPTIONS		
			BLACK	LAMINATE	VENEER

THREE SHELF BOOKCASE

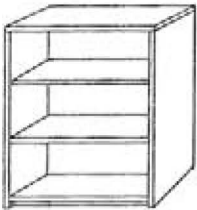

BC 1230-36	12 x 30 x 36	80	475	525	750
BC 1236-36	12 x 36 x 36	91	495	550	800
BC 1248-36	12 x 48 x 36	112	700	780	950

FOUR SHELF BOOKCASE

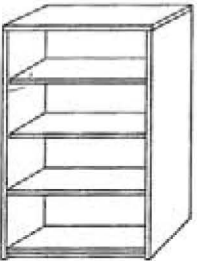

BC 1230-48	12 x 30 x 48	103	565	625	800
BC 1236-48	12 x 36 x 48	116	600	675	850
BC 1248-48	12 x 48 x 48	142	775	875	1000

FIVE SHELF BOOKCASE

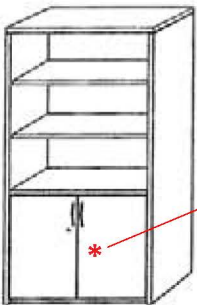

BC 1230-72	12 x 30 x 72	136	735	825	1000
BC 1236-72	12 x 36 x 72	151	760	895	1100
BC 1248-72	12 x 48 x 72	182	925	1000	1200

Hinged door option shown but not included. Refer to pt. 2 below.

WHEN ORDERING SPECIFY

- MODEL NUMBER & DESCRIPTION, INCLUDING OPTIONS
- SIZE
- EDGE DETAIL
- FINISH

NOTES & OPTIONS

- 1 FOUR HIGH BOOKCASE ALSO AVAILABLE 60" HIGH, FIVE HIGH BOOKCASE ALSO AVAILABLE 84" HIGH. CALL FOR PRICING
- 2 FOR LAMINATE DOORS 29" HIGH ADD \$160 LIST PER PAIR
- 3 FOR VENEER DOORS 29" HIGH ADD \$210 LIST PER PAIR

LATERAL FILES

EDGE DETAILS

MODEL NUMBER	SIZE D x W x H	WT.	EDGE DETAILS			
			GROUP 1	GROUP 2	GROUP 3	GROUP 4

CREDENZA LATERAL FILE

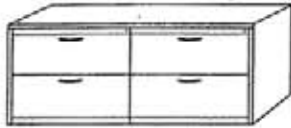

CLF 2060	20 x 60 x 29	300	1650	1725	1965	2300
CLF 2072	20 x 72 x 29	330	1725	1800	2100	2500

TWO HIGH LATERAL

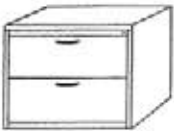

LF2 - 30	22 x 30 x 29	180	745	800	945	1300
LF2 - 36	22 x 36 x 29	210	765	825	985	1345
LF2 - 42	22 x 42 x 29	240	820	885	1140	1385

THREE HIGH LATERAL



LF3 - 30	22 x 30 x 41	230	950	1000	1200	1400
LF3 - 36	22 x 36 x 41	270	1000	1075	1225	1450
LF3 - 42	22 x 42 x 41	310	1120	1200	1375	1600

FOUR HIGH LATERAL



LF4 - 30	22 x 30 x 53	240	1350	1410	1550	1750
LF4 - 36	22 x 36 x 53	280	1375	1450	1595	1800
LF4 - 42	22 x 42 x 53	320	1475	1550	1720	2000

WHEN ORDERING SPECIFY

NOTES & OPTIONS

- MODEL NUMBER & DESCRIPTION, INCLUDING OPTIONS
- SIZE
- EDGE DETAIL
- FINISH

CRENZAS

EDGE DETAILS

MODEL NUMBER	SIZE D x W x H	WT.	EDGE DETAILS			
			GROUP 1	GROUP 2	GROUP 3	GROUP 4

HINGED DOOR CREENZA



HDC 2236	22 x 36 x 29	120	770	825	1000	1150
HDC 2248	22 x 48 x 29	205	875	945	1025	1185
HDC 2260	22 x 60 x 29	265	975	1075	1485	2100
HDC 2272	22 x 72 x 29	310	1080	1150	1655	2200

KNEE SPACE CREENZA

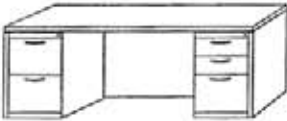

KSC 2260	22 x 60 x 29	260	1150	1245	1540	1775
KSC 2272	22 x 72 x 29	270	1250	1345	1680	1850

COMBINATION CREENZA

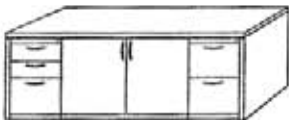

CC 2260	22 x 60 x 29	330	1288	1385	1700	2175
CC 2272	22 x 72 x 29	350	1340	1450	1830	2225

WHEN ORDERING SPECIFY

- MODEL NUMBER & DESCRIPTION, INCLUDING OPTIONS
- SIZE
- EDGE DETAIL
- FINISH

NOTES & OPTIONS

- FOR LOCKS - ADD \$60 LIST PER PAIR OF DOORS

- **KEY LOCKS/ CORES** - Caseloads locking storage uses the LAM3 series locks. LAM3 locks are available. They are sold separately through the Willow catalog.
- Please see Willow Pricebook for part numbers and pricing.

STORAGE UNITS - 36" HIGH

EDGE DETAILS

MODEL NUMBER	SIZE D x W x H	WT.	EDGE DETAILS			
			GROUP 1	GROUP 2	GROUP 3	GROUP 4

HINGED DOOR STORAGE CABINET W/ DRAWERS - 36"H

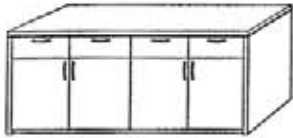

HDCD 2436	24 x 36 x 36	120	1150	1250	1675	1875
HDCD 2448	24 x 48 x 36	205	1300	1390	2150	2400
HDCD 2460	24 x 60 x 36	265	1650	1725	2750	3000
HDCD 2472	24 x 72 x 36	310	1800	1925	2950	3150
HDCD 2484	24 x 84 x 36	330	2000	2275	3000	3375

HINGED DOOR STORAGE CABINET - 36"H

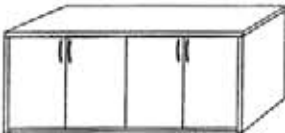

HDC 2436	24 x 36 x 36	120	990	1050	1200	1400
HDC 2448	24 x 48 x 36	205	1110	1200	1440	1600
HDC 2460	24 x 60 x 36	265	1300	1470	1800	2200
HDC 2472	24 x 72 x 36	310	1500	1650	2175	2700
HDC 2484	24 x 84 x 36	330	1700	1850	2300	2850

WHEN ORDERING SPECIFY

- MODEL NUMBER & DESCRIPTION, INCLUDING OPTIONS
- SIZE
- EDGE DETAIL
- FINISH

NOTES & OPTIONS

- FOR LOCKS - ADD \$60 LIST PER PAIR OF DOORS

- **KEY LOCKS/ CORES** - Casegoods locking storage uses the LAM3 series locks. LAM3 locks are available. They are sold separately through the Willow catalog.
- Please see Willow Pricebook for part numbers and pricing.

STORAGE UNITS

EDGE DETAILS

MODEL NUMBER	SIZE D x W x H	WT.	EDGE DETAILS			
			GROUP 1	GROUP 2	GROUP 3	GROUP 4

HINGED DOOR/2 DWR LATERAL CABINET

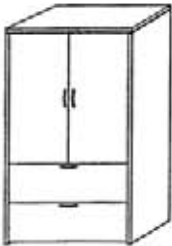

HDLF 2236 - 2	22 x 36 x 72	390	1650	1750	1800	2100
HDLF 2242 - 2	22 x 42 x 72	415	1700	1800	1945	2300

Includes 2 adjustable shelves.

Optional: Hinged door over hinged door cabinet.

HINGED DOOR/3 DWR LATERAL CABINET



HDLF 2236-3	22 x 36 x 72	390	1800	1900	2000	2375
HDLF 2242-3	22 x 42 x 72	415	1850	2000	2225	2600

WARDROBE CABINET

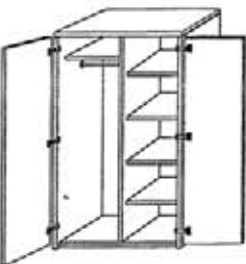

WC 2236	22 x 36 x 72	310	1500	1675	1850	2200
---------	--------------	-----	------	------	------	------

WHEN ORDERING SPECIFY

MODEL NUMBER & DESCRIPTION, INCLUDING OPTIONS

SIZE

EDGE DETAIL

FINISH

NOTES & OPTIONS

FOR LOCKS - ADD \$60 LIST PER PAIR OF DOORS

- KEY LOCKS/ CORES - Casegoods locking storage uses the LAM3 series locks. LAM3 locks are available. They are sold separately through the Willow catalog.
- Please see Willow Pricebook for part numbers and pricing.

VIDEO CABINETS

EDGE DETAILS

MODEL NUMBER	SIZE D x W x H	WT.	EDGE DETAILS			
			GROUP 1	GROUP 2	GROUP 3	GROUP 4

A.V. STAND

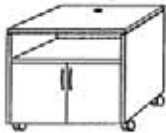

AVS 2230 - 36	22 x 30 x 36	260	950	1050	1175	1300
AVS 2236 - 38	22 x 36 x 36	275	1000	1150	1265	1380

A.V. Stand can hold upto 200 lbs.

A.V. CABINET

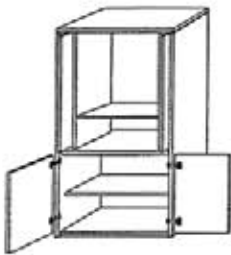

AVC 2236 - 72	22 x 36 x 72	360	1750	1925	2800	3000
AVC 2242 - 72	22 x 42 x 72	375	2000	2200	3000	3300

Upper half pocket doors are standard.

For drawer in upper cabinet - add \$250 and specify.

VCR shelf standard. For pull-out VCR shelf add \$225 list.

Grommets included.

TELEPHONE STAND



TS 1824 - 29	18 x 24 x 29	130	500	600	700	850
TS 2230 - 29	22 x 30 x 29	150	600	750	800	900

Specify left or right hinged door.

WHEN ORDERING SPECIFY

- MODEL NUMBER & DESCRIPTION, INCLUDING OPTIONS
- SIZE
- EDGE DETAIL
- FINISH

NOTES & OPTIONS

- CUSTOM UNITS AVAILABLE, CALL FOR PRICING

VISUAL BOARDS

MODEL NUMBER	SIZE H x W	WT.	OPTIONS	
			LAMINATE	VENEER

CABINET UNIT

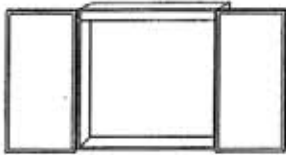

VBC 3636	36 x 36	80	1300	1450
VBC 3648	36 x 48	102	1375	1500
VBC 4848	48 x 48	128	1425	1600
VBC 4860	48 x 60	160	1560	1700
VBC 4872	48 x 72	192	1630	1800

For pull down projection screen - add \$175 list.

OPEN WITH TRAY



Radius Edge Frame with Tray

	SIZE H x W	WT.	LAMINATE	WOOD
			NO FRAME	FRAME
OVB 3636	36 x 36	36	400	625
OVB 3648	36 x 48	42	450	650
OVB 4848	48 x 48	48	550	700
OVB 4860	48 x 60	60	625	750
OVB 4872	48 x 72	72	700	800
OVB 4896	48 x 96	96	850	1025
OVB 48120	48 x 120	120	1000	1200

WHEN ORDERING SPECIFY

- MODEL NUMBER & DESCRIPTION, INCLUDING OPTIONS
- SIZE
- EDGE DETAIL
- FINISH

NOTES & OPTIONS

- CUSTOM UNITS AVAILABLE, CALL FOR PRICING
- VISUAL BOARD CABINET HAS TACKABLE FABRIC PANELS ON INSIDE OF DOORS STANDARD



TABLES

TABLES WITH 4" PANEL LEG BASE

EDGE DETAILS

MODEL NUMBER	SIZE D x W	WT.	EDGE DETAILS				
			GROUP 1	GROUP 2	GROUP 3	GROUP 4	GROUP 5

RECTANGULAR



RPB3672	36 x 72	165	775	850	1200	1750	1900
RPB3696	36 x 96	195	900	975	1375	1875	2300
RPB4296	42 x 96	210	1075	1120	1525	1925	2375
RPB4896	48 x 96	255	1125	1225	1575	2250	2650
RPB48120	48 x 120	345	1345	1475	1800	2525	3150
RPB48144	48 x 144	380	1565	1720	2300	2840	3600
RPB48168	48 x 168	445	1900	2090	2600	4100	4600
RPB48192	48 x 192	500	2300	2535	3000	4300	4870

RACETRACK OR CONVEX

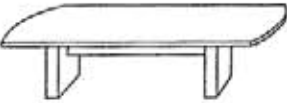

RTPB3672	36 x 72	165	925	1100	1650	1950	2300
RTPB3696	36 x 96	195	1050	1200	1850	2200	2700
RTPB4296	42 x 96	210	1120	1300	2000	2270	2760
RTPB4896	48 x 96	255	1175	1400	2110	2300	3075
RTPB48120	48 x 120	345	1500	1750	2285	2800	3400
RTPB48144	48 x 144	380	1700	1955	2600	3100	3900
RTPB48168	48 x 168	445	2300	2650	3300	4400	5000
RTPB48192	48 x 192	500	2525	2900	3600	4750	5300

BOAT SHAPE



BSPB243672	24 x 36 x 72	165	925	1100	1650	1950	2300
BSPB364296	36 x 42 x 96	210	1120	1300	2000	2270	2760
BSPB364896	36 x 48 x 96	255	1175	1400	2110	2300	3075
BSPB3648120	36 x 48 x 120	345	1500	1750	2285	2800	3400
BSPB3648144	36 x 48 x 144	380	1700	1955	2600	3100	3900
BSPB3648168	36 x 48 x 168	445	2300	2650	3300	4400	5000
BSPB3654192	36 x 54 x 192	500	2525	2900	3600	4750	5300

WHEN ORDERING SPECIFY

- MODEL NUMBER & DESCRIPTION, INCLUDING OPTIONS
- SIZE
- EDGE DETAIL
- FINISH

NOTES & OPTIONS

- SPECIFY SHAPE: RECTANGULAR, RACETRACK, CONVEX OR BOAT

TABLE WITH FULL OR HALF CYLINDER BASE

MODEL NUMBER	SIZE D x W	WT.	EDGE DETAILS				
			GROUP 1	GROUP 2	GROUP 3	GROUP 4	GROUP 5

RECTANGULAR

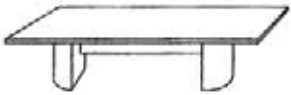
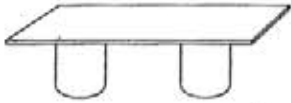

CRL3672	36 x 72	165	1250	1375	1655	1800	2000
CRL3696	36 x 96	195	1470	1600	1825	1980	2200
CRL4296	42 x 96	210	1600	1750	1945	2150	2475
CRL4896	48 x 96	255	1700	1825	2000	2225	2500
CRL48120	48 x 120	345	1950	2100	2400	2800	3200
CRL48144	48 x 144	380	2375	2600	2725	3100	3700
CRL48168	48 x 168	445	2800	3080	3440	4000	4500
CRL48192	48 x 192	500	3000	3275	3875	4500	4800

RACETRACK OR CONVEX

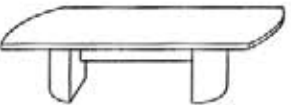
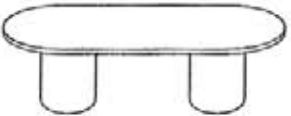

CRT3672	36 x 72	165	1425	1575	1935	2150	2600
CRT3696	36 x 96	195	1685	1830	2115	2350	2900
CRT4296	42 x 96	210	1800	1965	2320	2600	3100
CRT4896	48 x 96	255	1900	2050	2420	2700	3180
CRT48120	48 x 120	345	2200	2375	2850	3185	3525
CRT48144	48 x 144	380	2400	2600	3230	3590	4200
CRT48168	48 x 168	445	2950	3210	3750	4175	4900
CRT48192	48 x 192	500	3100	3420	4125	4590	5400

BOAT SHAPE

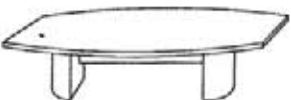
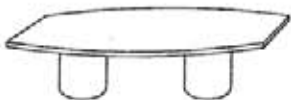

CBS243672	24 x 36 x 72	165	1425	1575	1935	2150	2600
CBS364296	36 x 42 x 96	210	1800	1965	2320	2600	3100
CBS364896	36 x 48 x 96	255	1900	2050	2420	2700	3180
CBS3648120	36 x 48 x 120	345	2200	2375	2850	3185	3525
CBS3648144	36 x 48 x 144	380	2400	2600	3230	3590	4200
CBS3648168	36 x 48 x 168	445	2950	3210	3750	4175	4900
CBS3654192	36 x 54 x 192	500	3100	3420	4125	4590	5400

WHEN ORDERING SPECIFY

- MODEL NUMBER & DESCRIPTION, INCLUDING OPTIONS
- SIZE
- EDGE DETAIL
- FINISH

NOTES & OPTIONS

- SPECIFY SHAPE: RECTANGULAR, RACETRACK, CONVEX OR BOAT
- SPECIFY FULL OR HALF CYLINDER BASE

TABLES WITH ATLAS T AND TT BASE

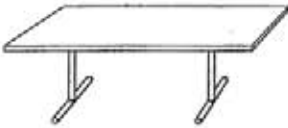
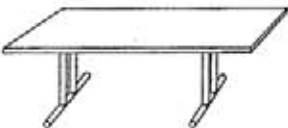
	MODEL NUMBER	SIZE D x W	WT.	EDGE DETAILS				
				GROUP 1	GROUP 2	GROUP 3	GROUP 4	GROUP 5
RECTANGULAR								
	RL2436 - 2	24 x 36	70	400	485	575	675	700
	RL2448 - 2	24 x 48	80	420	500	625	700	850
	RL2460 - 2	24 x 60	90	440	528	675	900	975
	RL2472 - 2	24 x 72	100	475	560	750	1050	1111
	RL2496 - 2	24 x 96	120	555	666	900	1250	1127
	RL3036 - 2	30 x 36	74	420	505	645	720	795
	RL3048 - 2	30 x 48	84	450	515	675	756	910
	RL3060 - 2	30 x 60	94	470	540	750	850	1000
	RL3072 - 2	30 x 72	104	500	600	825	930	1065
	RL3096 - 2	30 x 96	124	640	768	1025	1150	1353
	RL3648 - 2	36 x 48	92	500	600	750	900	1100
	RL3660 - 2	36 x 60	120	520	624	850	1000	1400
	RL3672 - 2	36 x 72	135	575	690	950	1200	1700
	RL3696 - 2	36 x 96	165	675	810	1100	1550	1875
	RL36120 - 3	36 x 120	195	975	1170	1400	1825	2750
RL4872 - 2	48 x 72	165	775	925	1250	1550	1825	
RL4896 - 2	48 x 96	205	950	1140	1460	1650	2100	
RL48120 - 3	48 x 120	246	1175	1410	1800	2150	2750	
RL48144 - 3	48 x 144	308	1400	1680	2070	2500	3300	
RL48168 - 4	48 x 168	348	1750	2010	2500	3800	4100	
RL48192 - 4	48 x 192	388	2100	2400	2700	4100	4500	

24" and 30" deep tables come with T base, 36" and 48" deep tables come with TT base.

WHEN ORDERING SPECIFY

- MODEL NUMBER & DESCRIPTION, INCLUDING OPTIONS
- SIZE
- EDGE DETAIL
- FINISH

NOTES & OPTIONS

- FOR STANDARD GROMMET ADD \$25
- BLACK POWDERCOAT BASE STANDARD
- FOR CASTERS: ADD \$15 LIST PER CASTER OR \$25 LIST PER LOCKING CASTER

TABLES WITH ATLAS T OR TT BASE

MODEL NUMBER	SIZE D x W	WT.	EDGE DETAILS				
			GROUP 1	GROUP 2	GROUP 3	GROUP 4	GROUP 5
RACETRACK OR CONVEX							
RT3672 - 2	36 x 72	135	800	900	1400	1600	2010
RT3696 - 2	36 x 96	165	875	985	1575	1780	2175
RT4296 - 2	42 x 96	185	1100	1232	1715	1975	2400
RT4896 - 2	48 x 96	205	1220	1366	1965	2100	2600
RT48120 - 3	48 x 120	246	1450	1624	2075	2350	3400
RT48144 - 3	48 x 144	308	1650	1848	2320	2800	3750
RT48168 - 4	48 x 168	348	2100	2350	2800	3100	4270
RT48192 - 4	48 x 192	388	2300	2600	2975	3500	4800

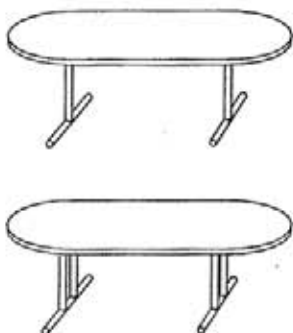

Specify Racetrack or Convex top.

BOAT SHAPE



BS243672 - 2	24 x 36 x 72	135	800	900	1400	1600	2010
BS364296 - 2	36 x 42 x 96	185	1100	1232	1715	1975	2400
BS364896 - 2	36 x 48 x 96	205	1220	1366	1965	2100	2600
BS3648120 - 3	36 x 48 x 120	246	1450	1624	2075	2350	3400
BS3648144 - 3	36 x 48 x 144	308	1650	1848	2320	2800	3750
BS3648168 - 4	36 x 48 x 168	348	2100	2350	2800	3100	4270
BS3654192 - 4	36 x 54 x 192	388	2300	2600	2975	3500	4800

36", 42" and 48" deep tables come with TT base.

WHEN ORDERING SPECIFY

- MODEL NUMBER & DESCRIPTION, INCLUDING OPTIONS
- SIZE
- EDGE DETAIL
- FINISH

NOTES & OPTIONS

- FOR STANDARD GROMMET ADD \$25
- BLACK POWDERCOAT BASE STANDARD
- FOR CASTERS: ADD \$15 LIST PER CASTER OR \$25 LIST PER LOCKING CASTER

TABLES WITH ATLAS FOLDING BASE

MODEL NUMBER	SIZE D x W	WT.	EDGE DETAILS				
			GROUP 1	GROUP 2	GROUP 3	GROUP 4	GROUP 5

RECTANGULAR WITH FOLDING "T" AND FOLDING "TT"

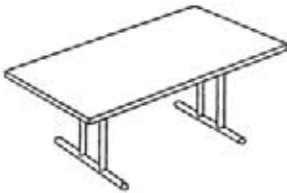

FRL2460 - 2	24 x 60	112	750	850	1035	1235	N/A
FRL2472 - 2	24 x 72	118	775	880	1250	1500	N/A
FRL3060 - 2	30 x 60	120	825	900	1250	1500	N/A
FRL3072 - 2	30 x 72	136	875	925	1300	1750	N/A
FRL3672 - 2	36 x 72	157	900	955	1330	1965	N/A
FRL3696 - 2	36 x 96	187	1025	1075	1575	2175	N/A
FRL4272 - 2	42 x 72	172	1350	1485	1830	2300	N/A
FRL4296 - 2	42 x 96	202	1550	1700	2090	2500	N/A

24" and 30" deep tables come with T base, 36" and 42" deep tables come with TT base.

WHEN ORDERING SPECIFY

- MODEL NUMBER & DESCRIPTION, INCLUDING OPTIONS
- SIZE
- EDGE DETAIL
- FINISH

NOTES & OPTIONS

- FOR CASTERS: ADD \$15 LIST PER CASTER OR \$25 LIST PER LOCKING CASTER

TABLE WITH ATLAS X BASE

MODEL NUMBER	SIZE D x W	WT.	EDGE DETAILS				
			GROUP 1	GROUP 2	GROUP 3	GROUP 4	GROUP 5
ROUND							
R30 - X	30 dia	40	375	390	775	925	1010
R36 - X	36 dia	52	400	440	800	950	1050
R42 - X	42 dia	69	550	605	1000	1200	1300
R48 - X	48 dia	96	620	682	1105	1300	1365
R54 - X	54 dia	104	850	935	1300	1485	1575
R60 - X	60 dia	126	900	990	1400	1625	1715



SQUARE

S3030 - X	30 x 30	46	350	385	743	875	985
S3636 - X	36 x 36	61	385	425	760	895	1025
S4242 - X	42 x 42	82	525	577	965	1125	1160
S4848 - X	48 x 48	108	625	690	1160	1225	1285
S5454 - X	54 x 54	129	725	797	1335	1400	1545
S6060 - X	60 x 60	153	775	860	1475	1550	1695

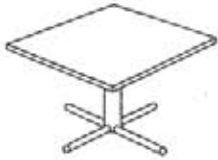





WHEN ORDERING SPECIFY

- MODEL NUMBER & DESCRIPTION, INCLUDING OPTIONS
- SIZE
- EDGE DETAIL
- FINISH

NOTES & OPTIONS

- FOR CASTERS: ADD \$15 LIST PER CASTER OR \$25 LIST PER LOCKING CASTER

TABLES WITH COLUMN BASE

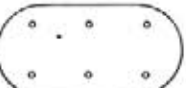
	MODEL NUMBER	SIZE D x W	WT.	EDGE DETAILS				
				GROUP 1	GROUP 2	GROUP 3	GROUP 4	GROUP 5
ROUND								
	R42	42 dia	72	775	875	1075	1150	N/A
	R48	48 dia	92	775	875	1075	1150	N/A
	R60	60 dia	122	935	1015	1536	1575	N/A
SQUARE								
	S4242	42 x 42	85	735	825	1000	1100	N/A
	S4848	48 x 48	105	735	825	1000	1100	N/A
	S6060	60 x 60	145	915	1000	1450	1500	N/A
HALF ROUND								
	HR2448	24 x 48	52	545	600	800	975	N/A
	HR3060	30 x 60	68	595	650	850	1000	N/A
	HR3672	36 x 72	92	705	785	975	1200	N/A
RECTANGULAR								
	RL2448	24 x 48	82	637	677	757	965	N/A
	RL3048	30 x 48	88	657	705	805	990	N/A
	RL3060	30 x 60	98	695	745	840	1075	N/A
	RL3672	36 x 72	114	757	820	1010	1315	N/A
	RL4896	48 x 96	185	1080	1130	1510	1765	N/A
	RL48120	48 x 120	225	1435	1500	1950	2200	N/A
RACETRACK								
	RT CT3672	36 x 72	114	1000	1075	1600	1795	N/A
	RT CT4896	48 x 96	185	1135	1255	2100	2325	N/A
	RT CT48120	48 x 120	225	1550	1675	2475	2700	N/A

WHEN ORDERING SPECIFY

- MODEL NUMBER & DESCRIPTION, INCLUDING OPTIONS
- SIZE
- EDGE DETAIL
- FINISH

NOTES & OPTIONS

- TELECOMMUNICATIONS GROMMET AVAILABLE - CALL FACTORY
- WIRE MANAGEMENT LEG AVAILABLE - CALL FACTORY

OCCASIONAL TABLES

EDGE DETAILS

MODEL NUMBER	SIZE D x W x H	WT.	EDGE DETAILS				
			GROUP 1	GROUP 2	GROUP 3	GROUP 4	GROUP 5

CUBE TABLE

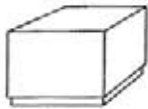

CT 1818	18 x 18 x 24	70	250	375	475	500
CT 2424	24 x 24 x 24	100	275	400	600	625
CT 3030	30 x 30 x 24	132	325	450	700	750

For recessed toe kick - add \$80 list.

CYLINDER TABLE



CYT 20	20 dia x 22	75	475	600	720	760
CYT 24	24 dia x 22	100	500	625	850	900
CYT 30	30 dia x 22	135	600	725	1075	1150
CYT 36	36 dia x 22	170	675	800	1175	1275

For recessed toe kick - add \$80 list.

PARSONS LEG TABLE



PLT 1836	18 x 36	55	515	575	875	975
PLT 1848	18 x 48	60	575	645	1000	1100
PLT 1860	18 x 60	67	625	700	1145	1270
PLT 2248	22 x 48	65	685	765	1095	1220
PLT 2260	22 x 60	77	720	805	1215	1350
PLT 2272	22 x 72	89	750	840	1350	1500

Available 24" high or 29" high, please specify.

WHEN ORDERING SPECIFY

- MODEL NUMBER & DESCRIPTION, INCLUDING OPTIONS
- SIZE
- EDGE DETAIL
- FINISH

NOTES & OPTIONS

RECEPTION STATIONS

BASIC RECEPTION STATION

EDGE DETAILS

MODEL NUMBER	SIZE D x W	WT.	EDGE DETAILS			
			GROUP 1	GROUP 2	GROUP 3	GROUP 4

BASIC FRONT DESK

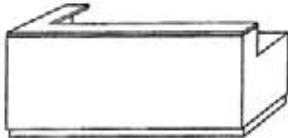

BD 3072	30 x 72	360	1865	*	*	3500
BD 3096	30 x 96	425	2000	*	*	4775
BD 30120	30 x 120	460	2700	*	*	5500

* Call factory for pricing.

For transaction counter options see page 30.

Includes one BBF locking pedestal per station. Specify front desk or return for pedestal location.

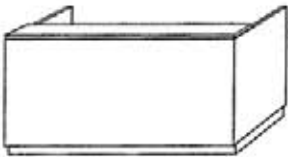

BASIC RETURN W/ TRANSACTION COUNTER

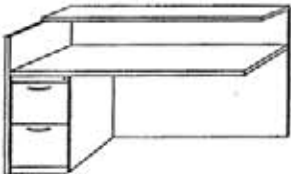

BR 2436	24 x 36	165	925	*	*	1450
BR 2448	24 x 48	180	1000	*	*	1700
BR 2460	24 x 60	210	1100	*	*	2000
BR 2472	24 x 72	225	1325	*	*	2600

BR 3036	30 x 36	185	975	*	*	1500
BR 3048	30 x 48	200	1025	*	*	2000
BR 3060	30 x 60	230	1175	*	*	2400
BR 3072	30 x 72	245	1450	*	*	2800

* Call factory for pricing.

Specify left or right return.

Returns are standard at 29" H.

For transaction counter options see page 30.

Shown with optional FF pedestal. Not included in price unless pedestal is not specified in front desk.

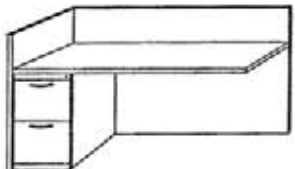

WHEN ORDERING SPECIFY

- MODEL NUMBER & DESCRIPTION, INCLUDING OPTIONS
- SIZE
- EDGE DETAIL
- FINISH
- GROMMET LOCATION

NOTES & OPTIONS

- EACH RECEPTION STATION INCLUDES 1 PEDESTAL WHICH CAN BE SPECIFIED IN FRONT DESK OR, IF SPECIFIED, IN THE RETURN - FOR ADDITIONAL COMPONENTS, SEE PAGE 36
- ONE GROMMET STANDARD
- FOR LAMINATE REVEAL ADD \$300
FOR BRUSHED METAL REVEAL ADD \$500
- ADD \$20 PER FOOT FOR WIRE MANAGER
- FOR TASK LIGHT ADD \$175