

MESA

**PRICE  
BOOK**

**FRÍANT**

MESA  
brings the  
office together!

**ALL  
WORKSTYLES  
WELCOME**

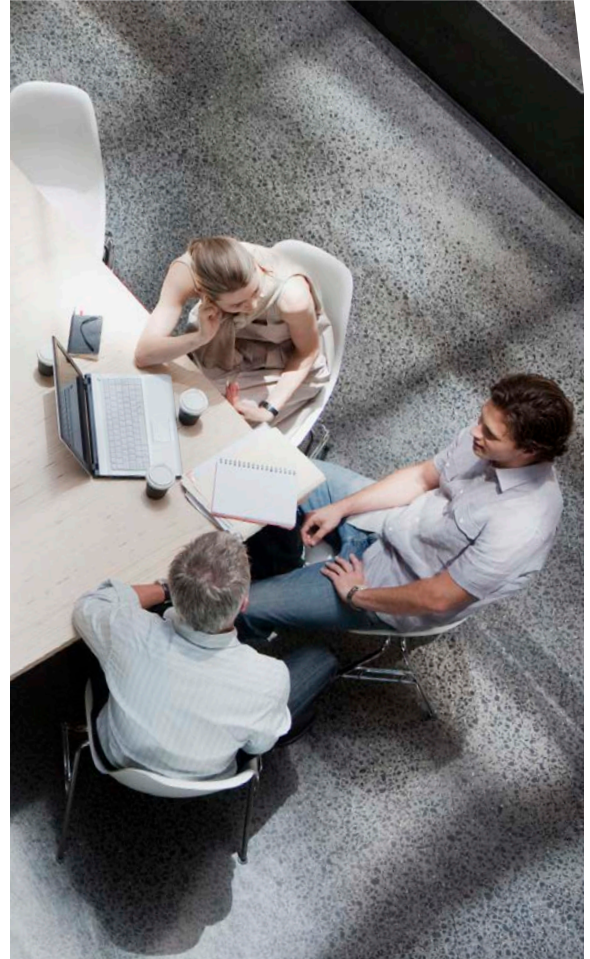

## THE ULTIMATE IN PLUG & PLAY CONFERENCING

---

Meeting set up has never been simpler. Friant's innovative inset trough holds voice, data, and electrical outlets that keep cables organized and out of sight for an uncluttered surface conducive to focus and planning. The trough has a brushed opening and the capacity for enough voice/data and electrical wiring to power up each seat at the table. Additional cable storage space in bases.

---



---

Beneath Mesa's beauty is an ingenious design — power trough and bases that store and organize cables for a complete plug and play experience

---

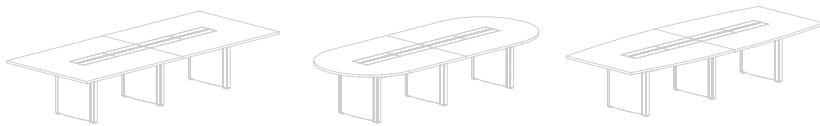

### **Trough Intelligence**

Friant's innovative trough organizes voice, data, and electrical cables with separate raceways for power and data.

### **Custom without cost**

With three table shapes, a dozen edge finishes and multiple base finish options, each Mesa table can be designed with a unique aesthetic. Mesa marries beauty and functionality while remaining at a competitive price point.

CASEGOODS  
CONFERENCE  
**MESA**



Cables have two entry points to the power and data ports – through the top doors and the base columns with detachable covers.

Open channel in base also holds cables and wires

Mesa makes connectivity easy with IT access integral to its design.

## VOICE & DATA

Separate channels for voice and data keeps the cable area organized

Voice/data jacks and wiring not included.

## POWER

Power capacity matches table seating, so each person at the table has a power and data outlet.

### example:

An 8 ft. table has 8 outlets, a 12 ft. table has 12 outlets, etc.

Power strips are single circuit soft wire style plug-in.

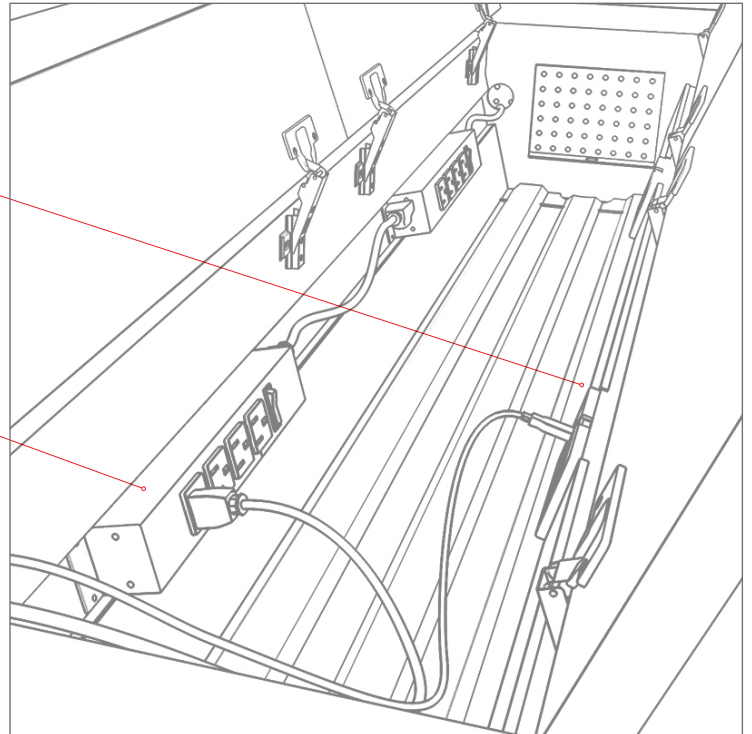

For dimensions, see page 14.



CASEGOODS  
CONFERENCE  
**MESA**



---

Mesa is as environmentally sound as it is innovative, with materials that offer air quality assurance and LEED point contributions for recycled content

---

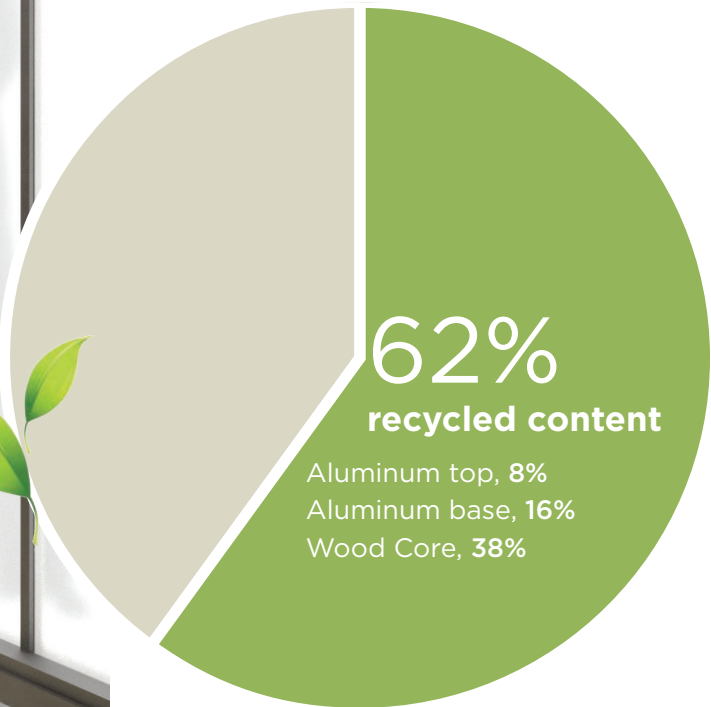

\*LEED point contributions will vary according to table specifications; this chart references the table shown on page 6, left.

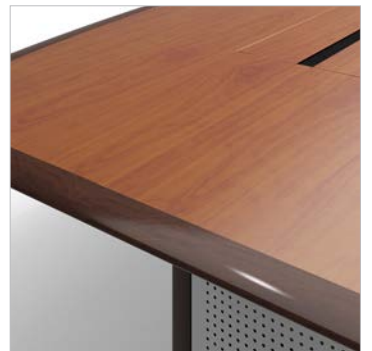

## ORDERING MESA IS EASY! 4 SIMPLE STEPS:

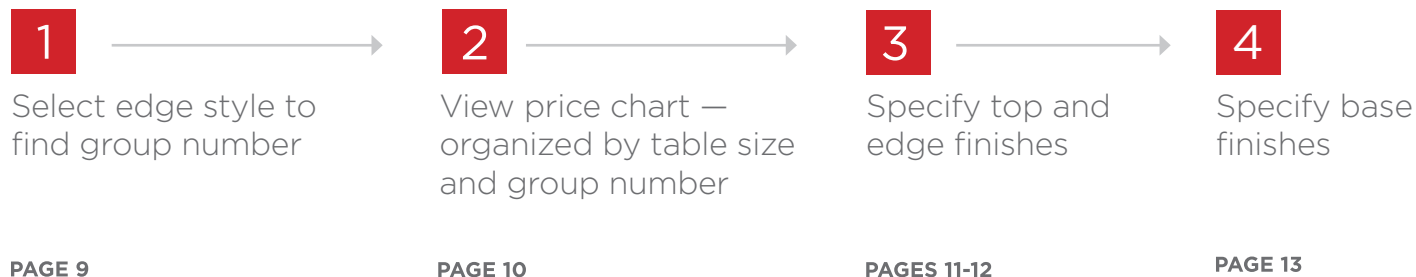

## ANATOMY OF A PRODUCT NUMBER

**MTB-BT-3648240-10-K**

MODEL NO.

EDGE GROUP

EDGE STYLE

Model numbers are found in the pricing table on page 10. Add the edge group and style to create the complete product number for your Mesa table.

**Be sure to specify finishes and base options in the description of your order.**

### Example:

MTB-BT-3648240-10-K

### Description:

Mesa Table, Boatshaped, 36 x 48 x 240, Style Group 10, Edge Style K

<b>Top Finish:</b>	VNO1	American Cherry
<b>Edge Finish:</b>	ED01	American Cherry
<b>Base Inset Finish:</b>	MT01	Clouds
<b>Base Column Finish:</b>	VPOL	American Cherry

American Cherry top and edge, with Clouds base inset and American Cherry base columns



# 1 SELECT STYLE GROUP

Your choice of top and edge material determines your edge style options.



Laminate (self) edge    PVC edge

## Group 1

Laminate top with laminate or PVC edge



## Group 9

Laminate top with solid wood edge



## Group 10

Veneer top with solid wood edge



## Group 11

Metal top with solid wood edge

Available Edge Styles: A & B

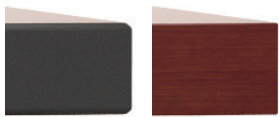

A 3 mm PVC    B Self Edge

Available Edge Styles: J, K, L, M, N, P, Q



J Radius



K Bevel



L Beaded



M Knife



N Reverse Knife



P Double Radius



Q Bullnose

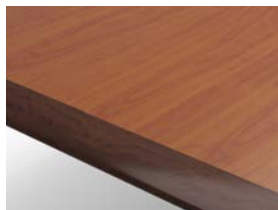

## Group 12

Laminate top with solid wood edge

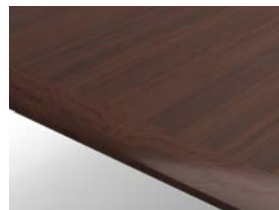

## Group 13

Veneer top with solid wood edge

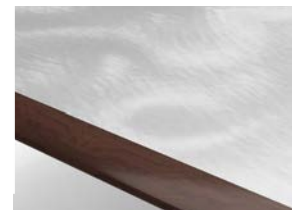

## Group 14

Metal top with solid wood edge

Available Edge Styles: S, T, W



S Ellipse 2.5"



T Ellipse 3.5"



W Ellipse 4.5"

## 2 FIND STYLE GROUP PRICING

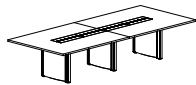

Rectangle Table

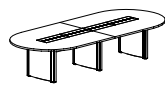

Racetrack Table

Size	Model No.	Model No.	Group 1	Group 9	Group 10	Group 11	Group 12	Group 13	Group 14
4' x 8'	MTB-RE-4896	MTB-RT-4896	\$8,919	\$13,825	\$15,162	\$17,190	\$17,839	\$19,623	\$21,650
4' x 9'	MTB-RE-48108	MTB-RT-48108	\$9,772	\$15,147	\$16,612	\$19,147	\$19,544	\$21,499	\$24,033
4' x 10'	MTB-RE-48120	MTB-RT-48120	\$11,645	\$18,051	\$19,797	\$22,331	\$23,292	\$25,620	\$28,155
4' x 11'	MTB-RE-48132	MTB-RT-48132	\$13,619	\$21,109	\$23,151	\$27,206	\$27,237	\$29,962	\$34,016
4' x 12'	MTB-RE-48144	MTB-RT-48144	\$14,148	\$21,929	\$24,051	\$28,105	\$28,296	\$31,125	\$35,179
4' x 14'	MTB-RE-48168	MTB-RT-48168	\$16,276	\$25,230	\$27,671	\$31,726	\$32,554	\$35,809	\$39,864
4' x 16'	MTB-RE-48192	MTB-RT-48192	\$17,101	\$26,506	\$29,071	\$35,152	\$34,201	\$37,622	\$43,703
4' x 18'	MTB-RE-48216	MTB-RT-48216	\$20,596	\$31,925	\$35,014	\$41,096	\$41,193	\$45,313	\$51,394
4' x 20'	MTB-RE-48240	MTB-RT-48240	\$21,552	\$33,405	\$36,640	\$42,718	\$43,104	\$47,415	\$53,496
4' x 22'	MTB-RE-48264	MTB-RT-48264	\$23,402	\$36,250	\$39,784	\$45,867	\$46,804	\$51,486	\$57,567
5' x 10'	MTB-RE-60120	MTB-RT-60120	\$13,894	\$21,535	\$23,618	N/A	\$27,786	\$30,565	N/A
5' x 12'	MTB-RE-60144	MTB-RT-60144	\$16,345	\$25,334	\$27,786	N/A	\$32,103	\$35,959	N/A
5' x 14'	MTB-RE-60168	MTB-RT-60168	\$18,052	\$27,980	\$27,985	N/A	\$36,103	\$39,715	N/A
5' x 16'	MTB-RE-60192	MTB-RT-60192	\$19,720	\$30,567	\$33,525	N/A	\$39,442	\$43,384	N/A
5' x 18'	MTB-RE-60216	MTB-RT-60216	\$23,528	\$36,468	\$39,999	N/A	\$47,056	\$51,760	N/A
5' x 20'	MTB-RE-60240	MTB-RT-60240	\$25,328	\$39,258	\$43,057	N/A	\$46,600	\$55,721	N/A
5' x 22'	MTB-RE-60264	MTB-RT-60264	\$26,756	\$41,471	\$45,485	N/A	\$53,513	\$58,863	N/A

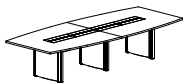









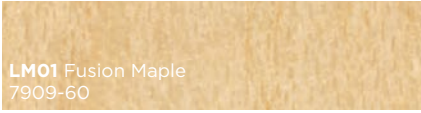
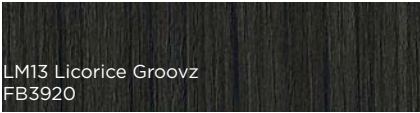
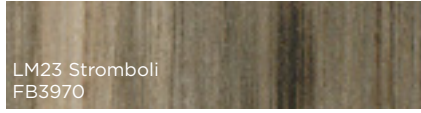
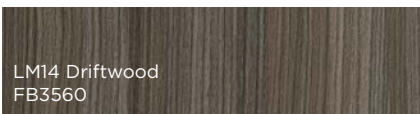
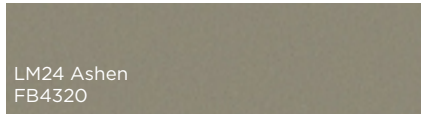
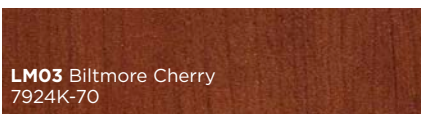

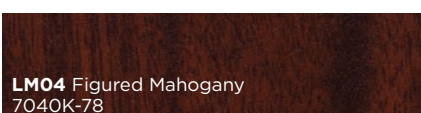
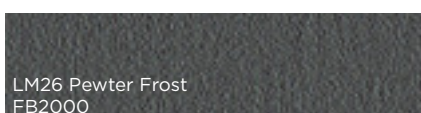
Boatshape Table

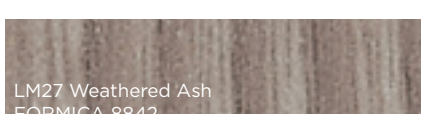
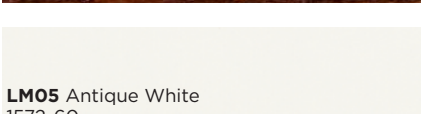
Size	Model No.	Group 1	Group 9	Group 10	Group 11	Group 12	Group 13	Group 14
3' x 4' x 8'	MTB-BT-364896	\$8,919	\$13,825	\$15,162	\$17,190	\$17,839	\$19,623	\$21,650
3' x 4' x 9'	MTB-BT-3648108	\$9,772	\$15,147	\$16,612	\$19,147	\$19,544	\$21,499	\$24,033
3' x 4' x 10'	MTB-BT-3648120	\$11,645	\$18,051	\$19,797	\$22,331	\$23,292	\$25,620	\$28,155
3' x 4' x 11'	MTB-BT-3648132	\$13,619	\$21,109	\$23,151	\$27,206	\$27,237	\$29,962	\$34,016
3' x 4' x 12'	MTB-BT-3648144	\$14,148	\$21,929	\$24,051	\$28,105	\$28,296	\$31,125	\$35,179
3' x 4' x 14'	MTB-BT-3648168	\$16,276	\$25,230	\$27,671	\$31,726	\$32,554	\$35,809	\$39,864
3' x 4' x 16'	MTB-BT-3648192	\$17,101	\$26,506	\$29,071	\$35,152	\$34,201	\$37,622	\$43,703
3' x 4' x 18'	MTB-BT-3648216	\$20,596	\$31,925	\$35,014	\$41,096	\$41,193	\$45,313	\$51,394
3' x 4' x 20'	MTB-BT-3648240	\$21,552	\$33,405	\$36,640	\$42,718	\$43,104	\$47,415	\$53,496
3' x 4' x 22'	MTB-BT-3648264	\$23,402	\$36,274	\$39,784	\$45,867	\$46,804	\$51,486	\$57,567
4' x 5' x 10'	MTB-BT-4860120	\$13,894	\$21,535	\$23,618	N/A	\$27,786	\$30,565	N/A
4' x 5' x 12'	MTB-BT-4860144	\$16,345	\$25,334	\$27,786	N/A	\$32,690	\$35,959	N/A
4' x 5' x 14'	MTB-BT-4860168	\$18,052	\$27,980	\$30,688	N/A	\$36,103	\$39,715	N/A
4' x 5' x 16'	MTB-BT-4860192	\$19,720	\$30,567	\$33,525	N/A	\$39,442	\$43,384	N/A
4' x 5' x 18'	MTB-BT-4860216	\$23,528	\$36,468	\$39,999	N/A	\$47,056	\$51,760	N/A
4' x 5' x 20'	MTB-BT-4860240	\$25,528	\$39,258	\$43,057	N/A	\$50,654	\$55,721	N/A
4' x 5' x 22'	MTB-BT-4860264	\$26,756	\$41,471	\$45,485	N/A	\$53,513	\$58,863	N/A

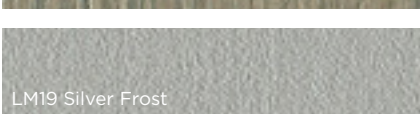
### 3 SELECT FINISHES: TOP

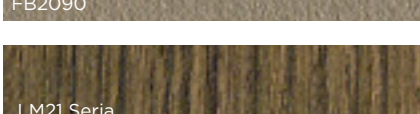
Table top finish choices includes laminate, veneer or metal. See chart below

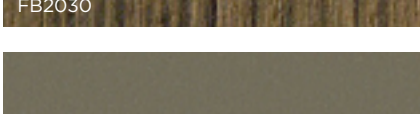
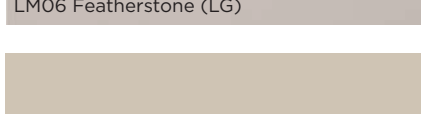
LAMINATES Edge Groups 1,9 & 12		
 LM01 Fusion Maple 7909-60	 LM13 Licorice Groovz FB3920	 LM23 Stromboli FB3970
 LM02 Wild Cherry 7054-60	 LM14 Driftwood FB3560	 LM24 Ashen FB4320
 LM03 Biltmore Cherry 7924K-70	 LM15 Mochatini FB2960	 LM25 Fog Grey FB2130
 LM04 Figured Mahogany 7040K-78	 LM16 Concrete Groovz FB3930	 LM26 Pewter Frost FB2000
 LM29 Windsor Mahogany 7039K-78	 LM17 Nirvana FB2990	 LM27 Weathered Ash FORMICA 8842
 LM05 Antique White 1572-60	 LM18 Aria FB3400	 LM28 White Ash FORMICA 8841
 LM09 Frosty White/CW 1573-60	 LM19 Silver Frost FB2100	 LM08 Black/BU 1595-60
 LM10 Cafelle 7933K-07	 LM20 Shadow Frost FB2090	 LM07 Slate Grey (MT) D91-60
 LM11 River Cherry 7937-60	 LM21 Seria FB2030	 LM06 Featherstone (LG)
 LM12 Walnut Heights 7965L-12	 LM22 Umbra FB4310	 LMNS Custom



#### CARB COMPLIANT

Willow laminates meet or exceed California (CARB) air quality emission standards — the most stringent in the country — for composite wood products.













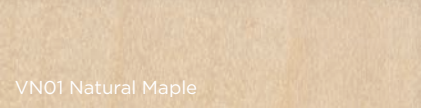
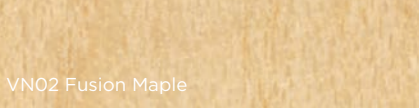
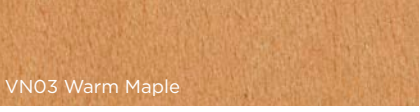
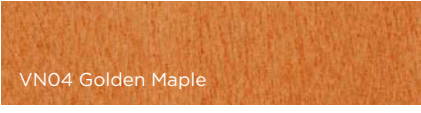
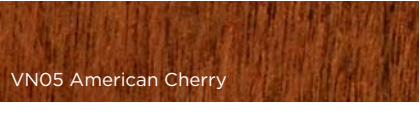
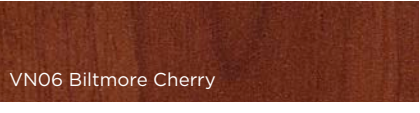

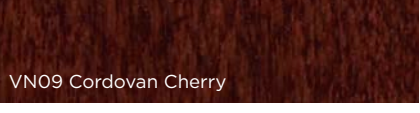
Order samples at [www.friant.com](http://www.friant.com)

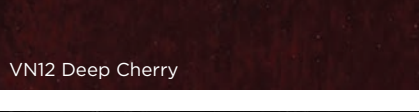
**Please Note:** Images are printed simulations and are not exact matches of finished product. Please request an actual sample from Friant or your sales consultant before specifying finishes.

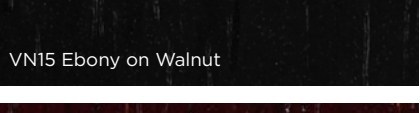
### 3 SELECT FINISHES: VENEER

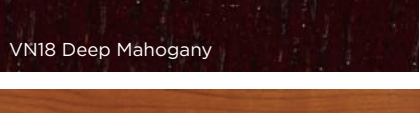
Table top finish choices: Veneer or Metal

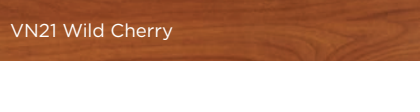
#### VENEER Edge Groups 10 & 13

 <p>VN01 Natural Maple</p>	 <p>VN02 Fusion Maple</p>	 <p>VN03 Warm Maple</p>
 <p>VN04 Golden Maple</p>	 <p>VN05 American Cherry</p>	 <p>VN06 Biltmore Cherry</p>
 <p>VN07 Warm Cherry</p>	 <p>VN08 Axiom Cherry</p>	 <p>VN09 Cordovan Cherry</p>
 <p>VN10 Medium Cherry</p>	 <p>VN11 Espresso</p>	 <p>VN12 Deep Cherry</p>
 <p>VN13 Warm Walnut</p>	 <p>VN14 Natural Walnut</p>	 <p>VN15 Ebony on Walnut</p>
 <p>VN16 Light Mahogany</p>	 <p>VN17 Medium Mahogany</p>	 <p>VN18 Deep Mahogany</p>
 <p>VN19 Natural Oak</p>	 <p>VN20 Medium Oak</p>	 <p>VN21 Wild Cherry</p>
 <p>VNNS Custom*</p>		

#### METAL Edge Groups 11 & 14

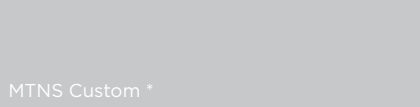
 <p>MT02 Clouds</p>	 <p>MT03 Coarse Grain</p>	 <p>MTNS Custom*</p>
--	---	---

\* For pricing on custom finishes, contact your Friant Sales Consultant.

### 3 SELECT FINISHES: EDGE

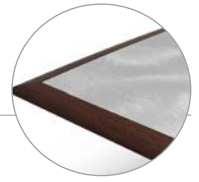

Table edge finish choices: solid wood

## SOLID WOOD EDGE

ED01 American Cherry

ED02 Biltmore Cherry

ED03 Warm Cherry

ED04 Axiom Cherry

ED05 Cordovan Cherry

ED06 Medium Cherry

ED07 Espresso

ED08 Deep Cherry

ED09 Warm Walnut

ED10 Natural Walnut

ED11 Ebony on Walnut

ED12 Natural Maple

ED13 Fusion Maple

ED14 Warm Maple

ED15 Golden Maple

ED16 Light Mahogany

ED17 Medium Mahogany

ED18 Deep Mahogany

ED19 Natural Oak

ED20 Medium Oak

ED21 Wild Cherry

EDNS Custom\*



Order samples at [www.friant.com](http://www.friant.com)

**Please Note:** Images are printed simulations and are not exact matches of finished product. Please request an actual sample from Friant or your sales consultant before specifying finishes.

### 3 SELECT FINISHES: EDGE

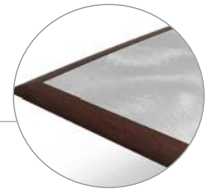
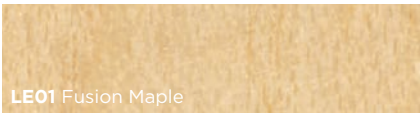
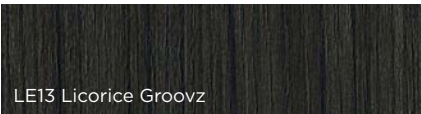

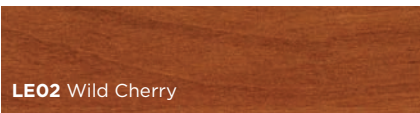
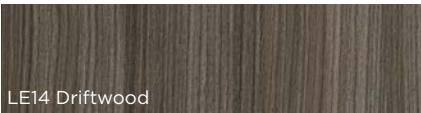
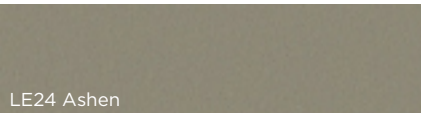
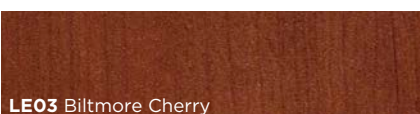







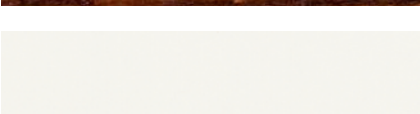
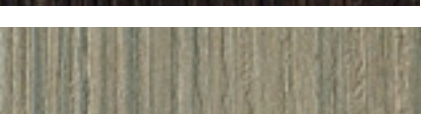

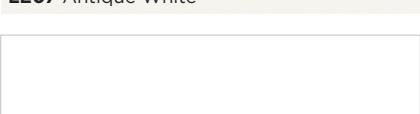

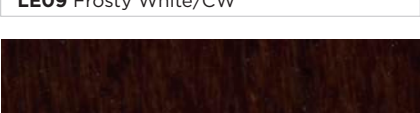
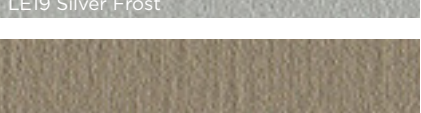





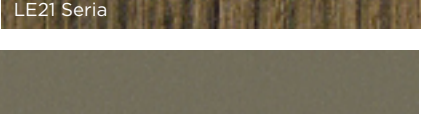
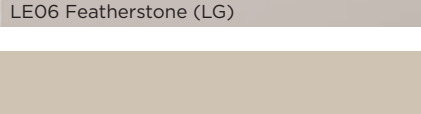
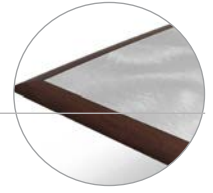

Table edge finish choices: Laminate and PVC.

## LAMINATE EDGE

 LE01 Fusion Maple	 LE13 Licorice Groovz	 LE23 Stromboli
 LE02 Wild Cherry	 LE14 Driftwood	 LE24 Ashen
 LE03 Biltmore Cherry	 LE15 Mochatini	 LE25 Fog Grey
 LE04 Figured Mahogany	 LE16 Concrete Groovz	 LE26 Pewter Frost
 LE29 Windsor Mahogany	 LE17 Nirvana	 LE27 Weathered Ash
 LE07 Antique White	 LE18 Aria	 LE28 White Ash
 LE09 Frosty White/CW	 LE19 Silver Frost	 LE08 Black/BU
 LE10 Cafelle	 LE20 Shadow Frost	 LE05 Slate Grey (MT)
 LE11 River Cherry	 LE21 Seria	 LE06 Featherstone (LG)
 LE12 Walnut Heights	 LE22 Umbra	 LMNS Custom



**PVC EDGE**

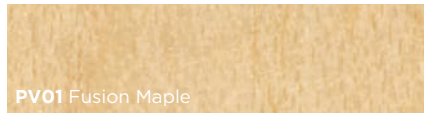

PV01 Fusion Maple

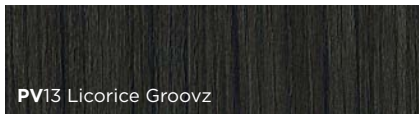

PV13 Licorice Groovz



PV23 Stromboli

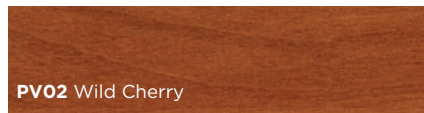

PV02 Wild Cherry



PV14 Driftwood

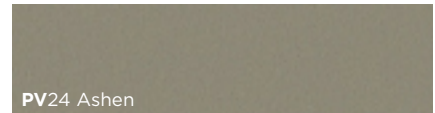

PV24 Ashen

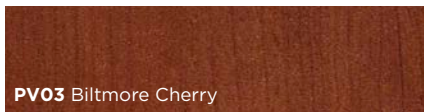

PV03 Biltmore Cherry



PV15 Mochatini



PV25 Fog Grey



PV04 Figured Mahogany

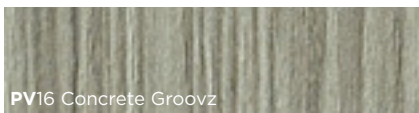

PV16 Concrete Groovz

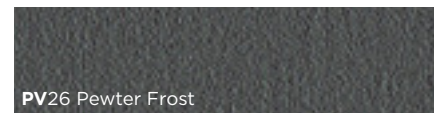

PV26 Pewter Frost



PV29 Windsor Mahogany



PV17 Nirvana

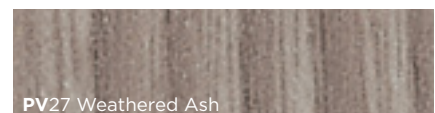

PV27 Weathered Ash

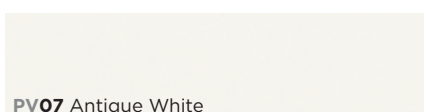

PV07 Antique White



PV18 Aria

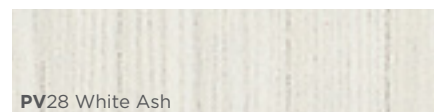

PV28 White Ash



PV09 Frosty White/CW



PV19 Silver Frost



PV08 Black/BU



PV10 Cafelle



PV20 Shadow Frost



PV05 Slate Grey (MT)

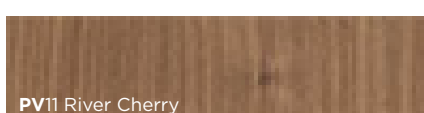

PV11 River Cherry

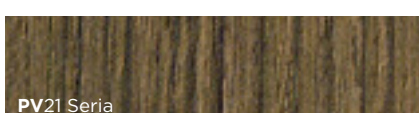

PV21 Seria

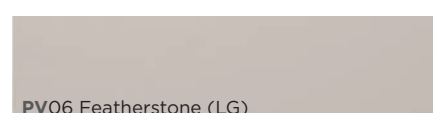

PV06 Featherstone (LG)

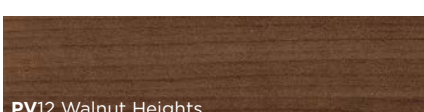

PV12 Walnut Heights

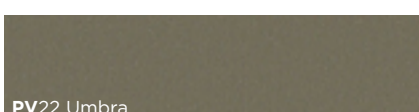

PV22 Umbra



LMNS Custom



Order samples at [www.friant.com](http://www.friant.com)

**Please Note:** Images are printed simulations and are not exact matches of finished product. Please request an actual sample from Friant or your sales consultant before specifying finishes.

## 4 SELECT BASE OPTION

Select an inset finish and column finish. A standard Mesa table has a perforated metal base inset and metal columns available in Aluminum, Black or White finish.

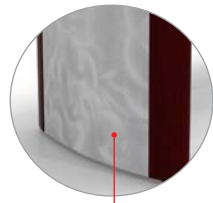

### Inset Finishes

Veneer, laminate and metal insets available with additional cost — see upcharge table below.

#### Metals (Standard):

- MBST** Perforated Aluminum
- MBSB** Perforated Black
- MBSW** Perforated White

#### Insets with upcharge:

- MB01** Clouds
- MB04** Coarse Grain
- MBNS** Custom\*

#### Veneers

- VBME** Match Edge
- VB01** American Cherry
- VB02** Biltmore Cherry
- VB03** Warm Cherry
- VB04** Axiom Cherry
- VB05** Cordovan Cherry
- VB06** Medium Cherry
- VB07** Espresso
- VB08** Deep Cherry
- VB09** Warm Walnut
- VB10** Natural Walnut
- VB11** Ebony on Walnut
- VB12** Natural Maple
- VB13** Fusion Maple
- VB14** Warm Maple
- VB15** Golden Maple
- VB16** Light Mahogany
- VB17** Medium Mahogany
- VB18** Deep Mahogany
- VB19** Natural Oak
- VB20** Medium Oak
- VB21** Wild Cherry
- VBNS** Custom\*

#### Laminates

- LB01** Fusion Maple
- LB02** Wild Cherry
- LB03** Biltmore Cherry
- LB05** Figured Mahogany
- LB07** Antique White
- LB08** Windsor Mahogany
- LB09** Black
- LB29** Frosty White
- LB10** Cafelle
- LB11** River Cherry
- LB12** Walnut Heights
- LB13** Licorice Groovz
- LB14** Driftwood
- LB15** Mochatini
- LB16** Concrete Groovz
- LB17** Nirvana
- LB18** Aria
- LB19** Silver Frost
- LB20** Shadow Frost
- LB21** Seria
- LB22** Umbra
- LB23** Stromboli
- LB24** Ashen
- LB25** Fog Grey
- LB26** Pewter Frost
- LB27** Weathered Ash
- LB28** White Ash
- LB04** Slate Grey
- LB06** Featherstone
- LBNS** Custom\*

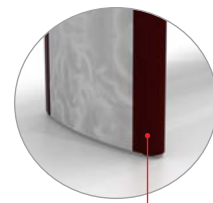

### Column Finishes

Veneer columns available with additional cost — see upcharge table below.

#### Metals (Standard):

- VCST** Aluminum
- VCSB** Black
- VCSW** White

#### Columns with upcharge:

#### Veneers

- VC01** American Cherry
- VC02** Biltmore Cherry
- VC03** Warm Cherry
- VC04** Axiom Cherry
- VC05** Cordovan Cherry
- VC06** Medium Cherry
- VC07** Espresso
- VC08** Deep Cherry
- VC09** Warm Walnut
- VC10** Natural Walnut
- VC11** Ebony on Walnut
- VC12** Natural Maple
- VC13** Fusion Maple
- VC14** Warm Maple
- VC15** Golden Maple
- VC16** Light Mahogany
- VC17** Medium Mahogany
- VC18** Deep Mahogany
- VC19** Natural Oak
- VC20** Medium Oak
- VC21** Wild Cherry
- VCNS** Custom\*

### Base Option Upcharges

Table length	Veneer Inset	Metal Inset	Laminate Inset	Veneer columns
8', 9', 10'	\$2,105	\$2,294	\$1,263	\$2,105
11', 12', 14', 16	\$3,158	\$3,442	\$1,895	\$3,158
18', 20', 22'	\$4,210	\$4,589	\$2,526	\$4,210

\*For pricing on custom finishes, contact your Friant Sales Consultant.



# SELECT BASE OPTION CONTINUED

## STANDARD MESA BASE: Matching inset and columns, 3 color choices.



**INSET:** Perforated metal  
 MBST Aluminum  
 MBSB Black  
 MBSW White

**COLUMNS:** Metal  
 VCST Aluminum  
 VCSB Black  
 VCSW White

Specify MBST/VCST, MBSB/VCSB, or MBSW/VCSW

## ADDITIONAL BASE DESIGNS: Please see upcharge chart, below.



**INSET:** Metal  
**COLUMNS:** Aluminum



**INSET:** Metal  
**COLUMNS:** Veneer



**INSET:** Laminate  
**COLUMNS:** Aluminum



**INSET:** Perforated Aluminum  
**COLUMNS:** Veneer



**INSET:**  
 Veneer

**COLUMNS:**  
 Aluminum

**SPECIFICATIONS  
CONFERENCE  
MESA**

**NUMBER OF DOORS, BASES AND SEAMS**

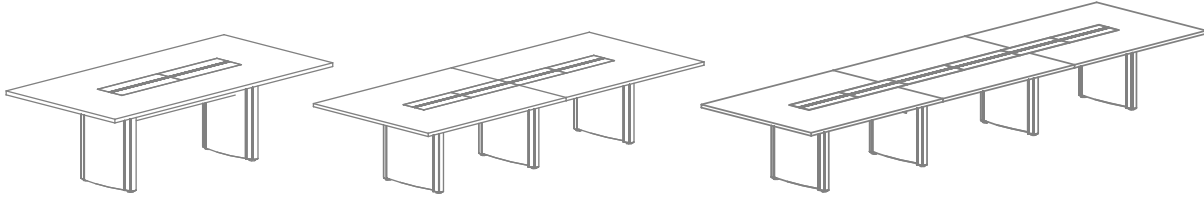
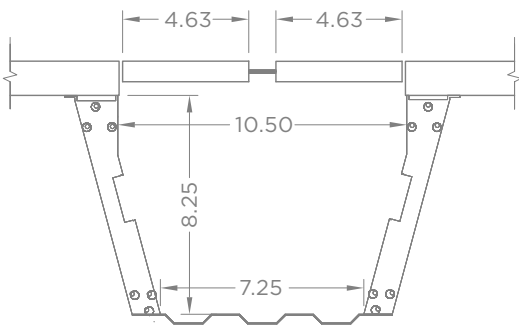

Table Length	8 ft	9 ft	10 ft	11 ft	12 ft	14 ft	16 ft	18 ft	20 ft	22 ft
Doors	4	4	4	4	8	8	8	12	12	12
Bases	2	2	2	3	3	3	3	4	4	4
Seams	0	1	1	1	1	1	2	2	2	2

**TROUGH DIMENSIONS**



**INSIDE BASE CLEARANCE**

Base for 48" Wide Top

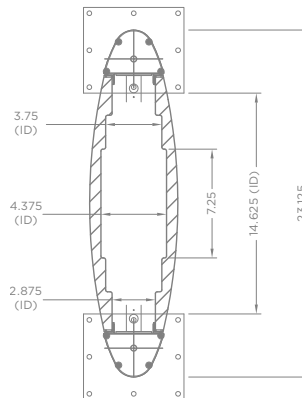

Base for 60" Wide Top

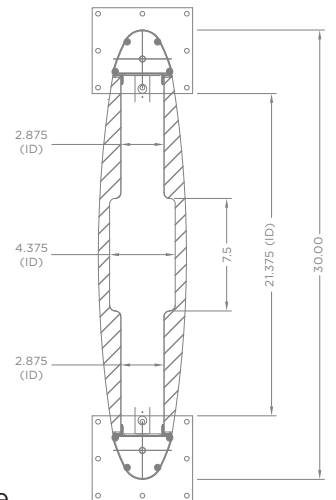

Drawings with base locations for core drilling are available at [www.friant.com](http://www.friant.com)

**CONFERENCE ROOM SEATING**



Description	Part #	Ht.	W.	D.	Features	List
High Back Madison	BJ-HBXSW-M	46-48 1/4"	25 1/4"	24 1/2"	<ul style="list-style-type: none"> <li>• PU leather seat and back</li> <li>• Aluminum polished armrest with PU arm pad</li> <li>• Height adjustable seat</li> <li>• Aluminum polished base</li> <li>• Nylon castors</li> </ul>	\$990
Mid Back Madison	BJ-MBXSW-M	39-41 1/4"	25 1/4"	25"		\$935

See full seating collection in our Seating catalog or online at [www.friant.com](http://www.friant.com)

## PRICES

All prices are F.O.B. point. We reserve the right to change prices without prior notice.

## ORDERING

Purchase Orders should be sent to Friant & Associates, LLC at orders@friant.com, or faxed to (510) 535-6895. If your specifications were created with CAP, GIZA, or Project Matrix please send the worksheet (SP4) with your Purchase Order.

## TERMS

Net 30 days from date of invoice with established terms. Invoices are delinquent if not paid (30) days from date of invoice. In the event timely payment is not made, interest will be charged at the rate of 1.5% per month on delinquent accounts. Buyers will also be liable for normal collection costs and attorney fees.

## ORDERS

Orders are only accepted by issuance of our formal acknowledgment, and are subject to the terms set forth herein and on our order acknowledgment. It is the responsibility of the buyer to review our acknowledgment for accuracy.

## LEAD TIME

Lead times are subject to availability.

## ORDER CHANGES AND CANCELLATIONS

Our order confirmation is final and binding. Any order change or cancellation is subject to our ability to conform. For the most up to date information, always review the order change/cancellation policy online. Allowable changes within the posted policy must be made in writing.

## RETURNS

No merchandise may be returned without our written consent and shipping instructions, and are subject to a 35% restocking fee. Unauthorized returns will not be accepted and will be returned freight collect. All packages are labeled with contents, and it is the customer's responsibility to check box labels against the packing list for accuracy before opening. If correctly labeled and undamaged product is removed from its original packaging, Friant will not accept its return.

## CLAIMS

We are not responsible for damage suffered in transit. Merchandise should be inspected for possible freight damage upon delivery. Claims for damage or shortages should be filed by the consignee with the carrier within 5 days of delivery. You are also protected for "concealed damage" if you file claim with the carrier within 5 days of delivery. All claims against Friant for defects, errors or shortages must be made by Buyer in writing within 10 days after delivery. Failure to make such a claim shall constitute full acceptance. All claims must be pre-approved and with a P.O. issued to Friant before reimbursement and/or reinstallation will be granted.

## SHIPPING

Friant generally palletizes, boxes and/or shrink wraps its products. If Buyer requests additional packaging or special shipping, extra charges will apply. Buyer obtains title to products and assumes the risk of loss for them upon shipment from Friant's plant.

## PARTIAL SHIPMENTS

We will make every attempt to ship orders complete and on schedule. However, we reserve the right to make partial shipments as merchandise is ready. Invoices covering these partial shipments are to be paid as they become due.

## SHIPPING AND PREPAID FREIGHT

Unless otherwise instructed, we reserve the option to ship by what is, in our opinion, the best possible way. Upon request, we will prepay and add freight for accounts with established credit. Please see our web site for estimated freight times.

## DELIVERY

We are not liable for delay or failure of delivery due to strikes and/or differences with workmen, war, riot, fire, compliance with government regulations, acts of nature, failure or delays of sources of supply, or any other causes beyond our control.

## STORAGE

If buyer cannot accept delivery when merchandise is ready, we reserve the right to transfer goods to storage. Costs of transfer and storage will be charged to the buyer's account, and we will deem such transfer as constituting shipment for all purposes, including invoicing, as of the date the transfer is made.

## CONSTRUCTION - SPECIFICATIONS

All items are produced to price list specifications unless otherwise advised. All dimensions shown are approximate. Manufacturer reserves the right to make modifications and/or improvements without prior notice.

## COMPLIANCE WITH LAW

Purchaser is solely responsible for compliance with all applicable Federal, State and Local laws, ordinances, regulations, rules and standards relating to the installation, maintenance, use and operation of products.

## TERMS & CONDITIONS MESA

### PRODUCT WARRANTY - 3 YEARS

This warranty is given to the initial purchaser and is valid from the date of purchase, for 3 years. This warranty covers defects in material and craftsmanship found during normal usage of the product during the warranty period. Normal usage is defined by 8 hour shifts in the product's intended application and in an indoor environment that conforms to the ANSI/ASHRAE Standard 55: Thermal Environmental Conditions for Human Occupancy (relating to air temperature, mean radiant temperature, air velocity, clothing insulation, metabolic rate, and humidity). Friant's warranty does not cover usage other than normal usage as defined in the previous sentence. If the product is defective, and if written notice of the defect is given to Friant & Associates within the applicable warranty period, Friant & Associates, at its option, will either repair or replace the defective product with a comparable component or product. This warranty applies to all products except as noted below.

High wear parts, such as fabrics, other covering material/finishes, foam, glides, etc. are warranted for One (1) Year. This warranty does not apply to damage caused by a carrier, alteration to the product not expressly authorized by Friant & Associates, nor to product considered to be of a consumable nature such as bulbs, light ballasts, etc. . It also does not apply to "Customer's Own Material" (i.e. material specified by the customer that is not a standard Friant & Associates offering) used in the manufacture of Friant & Associates products.

### WARRANTY EXCEPTIONS:

- Natural variations in wood grain, figure or the presence of character marks
- Matching of colors, grains, textures
- Changes in surface finishes due to aging or exposure to light
- Damage, marking or staining of surfaces due to contact with rubber or similar compounds
- Damage from sharp objects or imprinting from writing instruments, computer equipment or prolonged exposure to fluids or sun
- Checking or delaminating due to changes in temperature or improper care or storage
- Damage caused by misuse or improper care

Friant & Associates does not guarantee the matching of colors, grain or texture, except to within commercially acceptable standards. This includes normal variations between dye lots (fabrics).

A product will not be considered defective, and Friant & Associates will not be obligated to replace it, if it is not installed in a proper manner (i.e., product not leveled, not secured properly, etc.) or if it is not used in a manner and/or in an environment that constitutes normal usage, as defined above.

Except as noted above, Friant & Associates makes no express or implied warranties as to any product, and in particular makes no warranty of fitness for any particular use. At Friant & Associates' option, product repair and/or replacement are the customer's exclusive remedy for any and all product defects.

Friant & Associates shall not be liable for consequential, economic or incidental damages arising from any product defect.

### CALIFORNIA PROP 65 WARNING

Products in this catalog can expose you to chemicals including wood dust, which is known to the State of California to cause cancer or birth defects or other reproductive harm. For more information go to <https://www.p65warnings.ca.gov/products/furniture-products>."

### CARB

Friant products are CARB 93120 compliant for formaldehyde (phase 2)

### TSCA TITLE VI

Friant products are TSCA Title VI Compliant

### MAS

Accredited Compliance Designation - ANSI/BIFMA x7.1 & e3-2014 7.6.1, 7.6.2, 7.6.3

California Dept. Of Public Health Standard Method v1.2

Conforms With: LEED v4

Criteria of MAS Certified Green® Program

### CARE AND MAINTENANCE

Friant & Associates' finish provides excellent stain and mar resistance. Care should be exercised when cleaning. The following precautions will help keep the product looking new:

- Dust all surfaces on a regular basis with a soft damp cloth. Do not use spray polishes – especially those containing silicone.
- Lift all objects from the surface when moving – never drag objects across the surface.
- Metal objects should be kept from contacting the surface.